



Super**Systems**
incorporated

eSPP Recipe Programmer

Series 9010

OPERATIONS MANUAL

Super Systems Inc.

7205 Edington Drive

Cincinnati, OH 45249

513-772-0060

Fax: 513-772-9466

www.supersystems.com

Super Systems Inc.

USA Office

Corporate Headquarters:

7205 Edington Drive

Shipping Address:

7245 Edington Drive

Cincinnati, OH 45249

Phone: (513) 772-0060

<http://www.supersystems.com>

Super Systems Europe

Unit E, Tyburn Trading Estate,

Ashold Farm Road, Birmingham

B24 9QG

UNITED KINGDOM

Phone: +44 (0) 121 306 5180

<http://www.supersystemseurope.com>

Super Systems México

Sistemas Superiores Integrales S de RL de CV

Acceso IV No. 31 Int. H Parque Industrial

Benito Juarez

C.P. 76120 Queretaro, Qro.

Phone: +52 442 210 2459

<http://www.supersystems.com.mx>

Super Systems China

No. 369 XianXia Road

Room 703

Shanghai, CHINA

200336

Phone: +86 21 5206 5701/2

<http://www.supersystems.cn>

Super Systems India Pvt. Ltd.

A-26 Mezzanine Floor, FIEE Complex,

Okhla Indl. Area, Phase – 2

New Delhi, India 110 020

Phone: +91 11 41050097

<http://www.supersystemsindia.com>

Super Systems Inc. help desk:

1-513-772-0060

Table of Contents

Installation Safety Requirements	6
Chapter 1 - INSTALLATION.....	9
Overview	9
Mounting.....	9
Dimensional Drawings	10
24V DC Power Supply Dimensions.....	11
12" Operator Interface Cutout dimensionsWiring	12
Pin Out.....	13
Ancillary Items	14
ETHERNET Connections.....	15
Setup.....	15
Chapter 2 - OPERATION	16
Overview	16
Status Display	16
Menu	16
Chart	17
Chart Sub Menu.....	17
Recipe.....	18
Loops.....	20
Chapter 3 - CONFIGURATION	21
Logs	21
Auxiliary Analog Input	22
Manual Event Control.....	22
Shutdown	22
Recipe Edit	23
Load T/C Configuration	23
Trend Chart Edit	24
Communications Setup	25
Instrument Assignments	25
Zone Assignments	27
Furnace Setup.....	28
Security	29
Alarms.....	29
Event Hold/Reset.....	29
Aux Analog Input Setup	31
Configuration	31
T/C Correction Curves.....	42
Generic Instruments	42
Aux Input Offset Correction	44
Chapter 4 - Series 9010 "Opcodes"	45
Programmer Description	45
Opcodes.....	45
Wait	54
Wait Up.....	54
Wait Down.....	55
Wait in a Guaranteed Soak.....	56
Guarantee High Assignment	57
Guarantee Low Assignment.....	58
Chapter 5 - APPLICATIONS INFORMATION	59
Standard Event Assignments	59

Appendix A – Slave Instrument Mapping	60
Atmosphere Instruments	61
Temperature Instruments	64
Events Instruments.....	68
Appendix B – Series 9010 Wiring Diagram	71
Appendix C – Using MiniBatch with the 9010 Touchscreen	72
Appendix D – Data and Flash Card Management	73
Appendix E – Sample Recipe.....	77
Warranty.....	78
Revision History.....	79



Super**Systems**
incorporated

WARNINGS !!

Never remove the flashcard when the operator interface is ON. Follow the shutdown procedure in this manual. After you see the Windows desktop you can turn the power to the operator interface OFF by sliding the power switch to the left or disconnecting the 24VDC. This switch is located right above the connector bringing 24VDC power to the unit. This does not turn the controllers off.

Installation Safety Requirements

Safety Symbols

Various symbols are used on the instrument; they have the following meaning:



Caution, (refer to the accompanying documents)

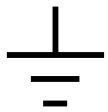

Functional earth (ground) terminal!

The functional earth connection is required for safety purposes and to ground RFI filters.

Personnel

Installation must only be carried out by technically qualified personnel.

Enclosure of live parts

To prevent hands or metal tools from touching parts that may be electrically live (powered), the controller must be installed in an enclosure.

Caution: Live sensors



Do not connect live (powered) sensors to any signal input on the controller. Live sensors are sensors that must be connected to the main's supply. The controller has transient protection circuits connected between the inputs and the earth connection that might be damaged by live (powered) sensors.

Wiring

It is important to connect the controller in accordance with the wiring data given in this handbook. Take particular care not to connect AC supplies to the low voltage power supply input. Use copper wires for 24V DC power supply to the instrument. Ensure that the wiring of installations comply with all local wiring regulations. For example in the United Kingdom use the latest version of the IEE wiring regulations, (BS7671). In the USA use NEC Class 1 wiring methods.

Power Isolation

The installation must include a power isolating switch or circuit breaker. This device should be in close proximity to the controller, within easy reach of the operator and marked as the disconnecting device for the instrument.

Earth leakage current

Due to RFI Filtering there is an earth leakage current of less than 0.5mA. This may affect the design of an installation of multiple controllers protected by Residual Current Device, (RCD) or Ground Fault Detector, (GFD) type circuit breakers.

Over current protection

To protect the internal PCB tracking within the controller against excess currents, the AC power supply to the controller and power outputs must be wired through a fuse or circuit breaker specified in the technical specification.

Voltage rating

The maximum continuous voltage applied between any of the following terminals must not exceed 24V DC

- relay or triac output to logic, DC or sensor connections;
- any connection to ground.

The controller should not be wired to VAC. The 24V DC power supply voltage across the connections and between the power supply and ground must not exceed 2.5kV. Where occasional voltage over 2.5kV are expected or measured, the power installation to both the instrument supply and load circuits should include a transient limiting device.

These units will typically include gas discharge tubes and metal oxide varistors that limit and control voltage transients on the supply line due to lightning strikes or inductive load switching. Devices are available in a range of energy ratings and should be selected to suit conditions at the installation.

Conductive pollution

Electrically conductive pollution must be excluded from the cabinet in which the controller is mounted. For example, carbon dust is a form of electrically conductive pollution. To secure a suitable atmosphere in conditions of conductive pollution, fit an air filter to the air intake of the cabinet. Where condensation is likely, for example at low temperatures, include a thermostatically controlled heater in the cabinet.

Over-temperature protection

When designing any control system it is essential to consider what will happen if any part of the system should fail. In temperature control applications the primary danger is that the heating will remain constantly on. Apart from spoiling the product, this could damage any process machinery being controlled, or even cause a fire. Reasons why the heating might remain constantly on include:

- the temperature sensor becoming detached from the process;
- thermocouple wiring becoming a short circuit;
- the controller failing with its heating output constantly on;
- an external valve or contactor sticking in the heating condition;
- the controller set point set too high.

Where damage or injury is possible, we recommend fitting a separate over temperature protection unit with an independent temperature sensor, which will isolate the heating circuit. Please note that the alarm relays within the controller will not give protection under all failure conditions.

Temperature range

The 9010 is designed to operate between 32°F - 132°F.

Installation requirements for EMC

To ensure compliance with the European EMC directive certain installation precautions are necessary as follows:

- When using relay or triac outputs it may be necessary to fit a filter suitable for suppressing the emissions. The filter requirements will depend on the type of load. For typical applications we recommend Schaffner FN321 or FN612.

Routing of wires

To minimize the pick-up of electrical noise, the wiring for low voltage dc should be routed away from high-current power cables. Where it is impractical to do this, use shielded cables with the shield grounded at one end.

Overview

The eSPP/9010 is a programmable instrument that is intended to connect to remote PID controllers via RS 485. With the use of the 9010 a simple single loop temperature and carbon controller can be used as a fully programmable control system with ramps, soaks, events and alarms. Additionally the 9010 allows for zone control for up to five instruments commonly used on continuous furnace applications. The 9010 allows for offsets between zones and includes a digital charting of the process at the touch screen. The 9010 can also serve as a data concentrator for various 485 instrumentation. These instruments can then be controlled or communicated via Ethernet to a supervisor software package such as SuperData.

The product is available in three different screen sizes. 3.5", 5.7" and 12".

Mounting

The Series 9010 Operator Interface mounts into a panel or on a plate by using the enclosed mounting brackets. A rectangular cutout is required; the size of the cutout is determined by the operator interface size.



1. There is an adhesive waterproof gasket on the front bezel. Ensure that the waterproof gasket is in place before installing the TPC system in the panel opening.
2. Install the TPC in the panel opening.
3. Retrieve the clamps and long screws from the accessory pack. Hook the clamps the holes located on the four sides of the bezel. Insert screws into every clamp and tighten them to fasten the clamp in place. These screws will push against the mounting panel and secure the unit.
4. The suggested mounting panel thickness is less than 6 mm (0.236 in).
5. The suggested mounting screw torque is 2 KGF-cm (kilogram-force centimeter) or 0.14 ft*lb (foot pound) (*Finger tight + ¼ turn + removable Loctite*)

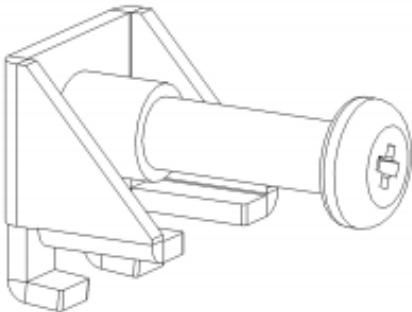

Insert the screws into each clamp and tighten them to fasten the clamp in place.

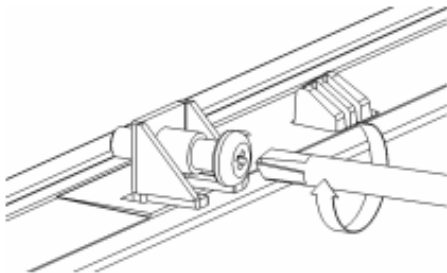

Hook the clamps into the holes and fasten the screws
Torque: 2 kgf-cm
These screws will push the mounting panel and secure the unit.

These units, along with an optional SR unit, will mount on a commercially available DIN rail. This can be mounted on the sub-panel on the side of an enclosure for the convenience of the control system.

Dimensional Drawings

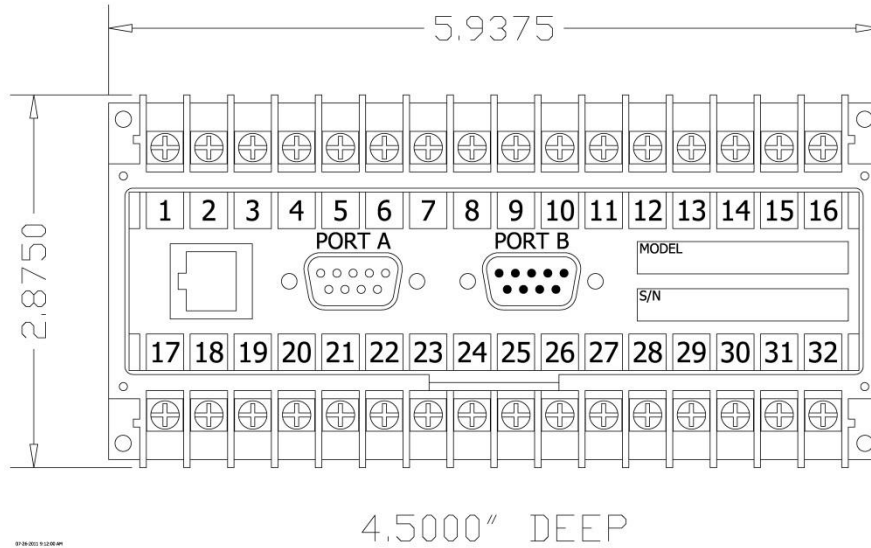

Series 9010 Controller Dimensions

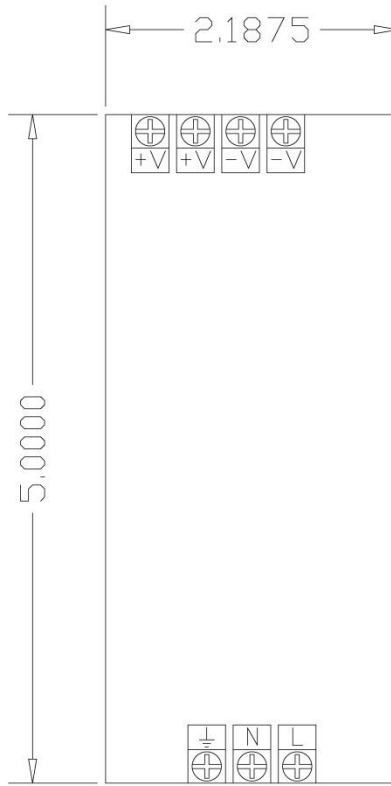

4.0000" DEEP

24V DC Power Supply Dimensions

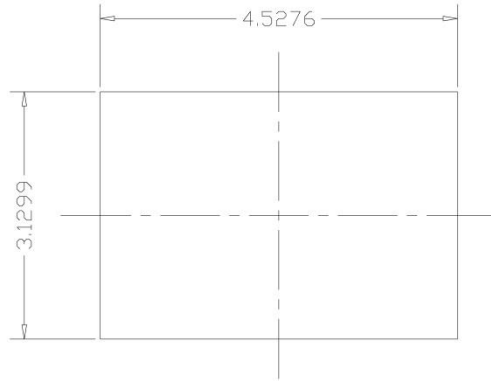

3.5" Operator Interface Cutout dimensions

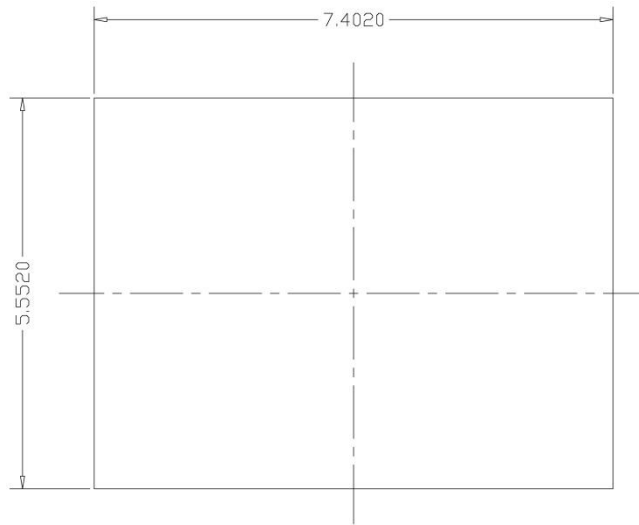

5.7" Operator Interface Cutout dimensions

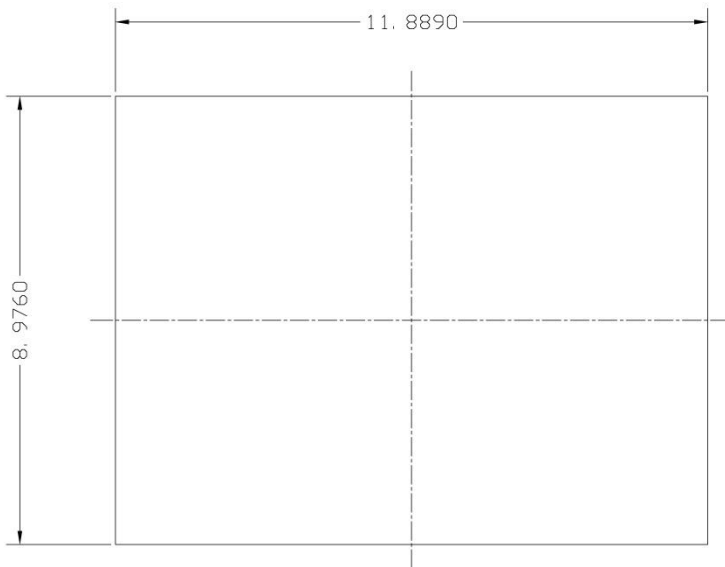

12" Operator Interface Cutout dimensions

Wiring

Wiring to the Series 9010 eSPP's operator interface can be done using 232 or 485 to two connectors, comm1 (232) or comm3 (485). The terminal strip on the lower right rear corner of the operator interface is used to connect 24VDC power. The DB-9 port A connection is used to connect the display via 232 to the Series 9010 PID controller. The eSPP is connected via RS485 communication to the single-loop controllers (AC20-Atmosphere and 7EK-Temperature).

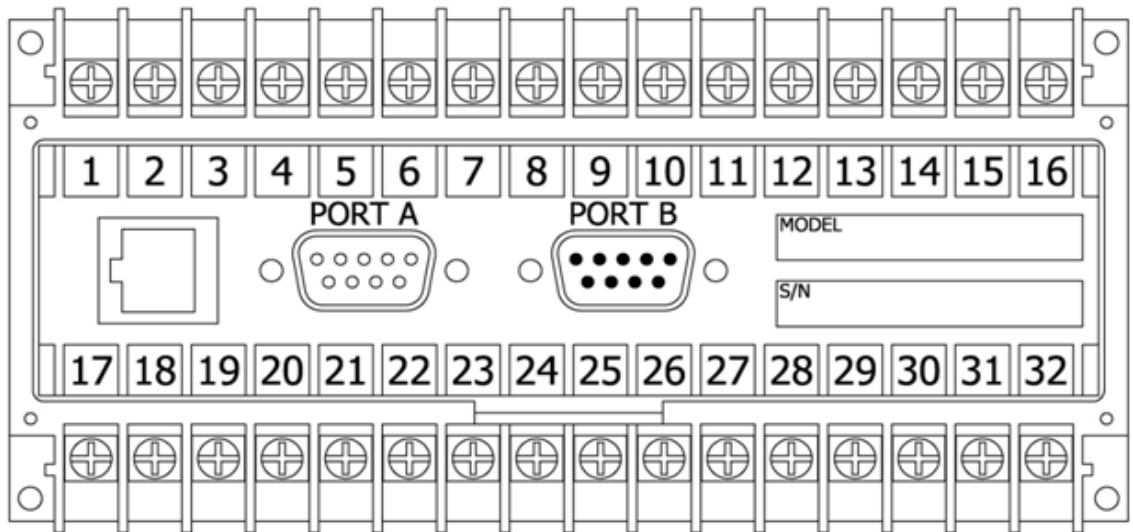

Model 9010 eSPP Terminal Assignments

Pin Out

SUPER SYSTEMS INC.

(800) 666-4330

www.supersystems.com

1 - 24VDC (COM)	12 - EVENT RELAY 4	22 - SLAVE 2 RS485 (+)
2 - 24VDC (+)	13 - EVENT RELAY 5	23 - SLAVE 2 RS485 (-)
3 - RS485 RT (-)	14 - EVENT RELAY 6	24 -
4 - RS485 RT (+)	15 - ALARM RELAY NC	25 -
5 - SLAVE 1 RS485 (-)	16 - ALARM RELAY NO	26 -
6 - SLAVE 1 RS485 (+)	17 - EVENT IN 0	27 -
7 - RELAY COMMON	18 - EVENT IN 1	28 -
8 - EVENT RELAY 0	19 - EVENT IN 2	29 -
9 - EVENT RELAY 1	20 - EVENT IN 3	30 -
10 - EVENT RELAY 2	21 - EVENT IN COM	31 -
11 - EVENT RELAY 3		32 -

9010 Pin Out

A wiring diagram of the Series 9010 controller can be found in Appendix B.

Ancillary Items

The following items can be included with the Series 9010: a flash card, a flash card reader, a touch screen, an RS-232 cable, a 24V DC DIN rail mount power supply, and a software CD with Configurator, the Configurator manual, TS Manager, .NET 2.0, and SD Recorder software. The flash card installs the operator interface and the flash card reader connects to a Windows® based computer. SD Recorder is a utility program that can be loaded on any current Windows® based computer. Its purpose is to read the data collected by the flash card and allow that data to be charted, similar to a strip chart recorder. Further information can be found in Appendix D, *Flash Card Management*. To install SD Recorder from the Installation CD, double-click on the SD_SDRcetup.exe file, and follow the instructions on your screen.

The operator interface includes connections for a mouse and a keyboard. These may be connected to the operator interface via USB, allowing the operators to use a mouse and keyboard instead of the touch screen.

The following table shows the ancillary items and their part numbers.

Part	Part Number
eSPP controller alone	13354

3.5" Operator Interface	13498
5.7" Operator Interface	13448
12" Operator Interface	13455
SD Recorder/PC Configurator Software	13339
Flash Card	13335
Flash Card Reader	13333
RS232 Cable	33027
24V DC Din Rail Mounted Power Supply	31135

ETHERNET Connections

This connection has two distinct uses. First, it allows a laptop to be connected to the Series 9010. This connection can act as a FULL FUNCTION operator interface using Configurator software. The laptop needs to be operating a current WINDOWS® based system with Internet Explorer. Secondly, if the instrument is connected to the customer's local intranet, then the instrument's information can be digitally logged and recorded using SSI software or another SCADA package. The default IP address is **192.168.0.200**. If you are experiencing problems please call 513-772-0060 and talk with our computer communications personnel.

Setup

The Series 9010 setup consists of setting the local time if required. As shipped from the factory the communications ports are set at 19200 baud in Modbus mode.

Time will be set for local time in Cincinnati, Ohio (EST /EDT) or time zone of location of city and state on sales order. For instruction on adjusting these values, please see *Chapter 3 - Configuration*.

Overview

- The Series 9010 eSPP Operator Interface is either a 3.5", 5.7", or 12.1" color, touch-screen display.
- On power-up, the Series 9010 will display a logo screen for sixty seconds and then switch to the default Status Screen.
- The active menu buttons on the status display are located at the bottom of the display.

Status Display

The Status display shows the atmosphere and temperature controller information as well as an overview of the programmer. There are four active buttons at the bottom of the Status Display: **Menu, Chart, Recipe, and Loops.**

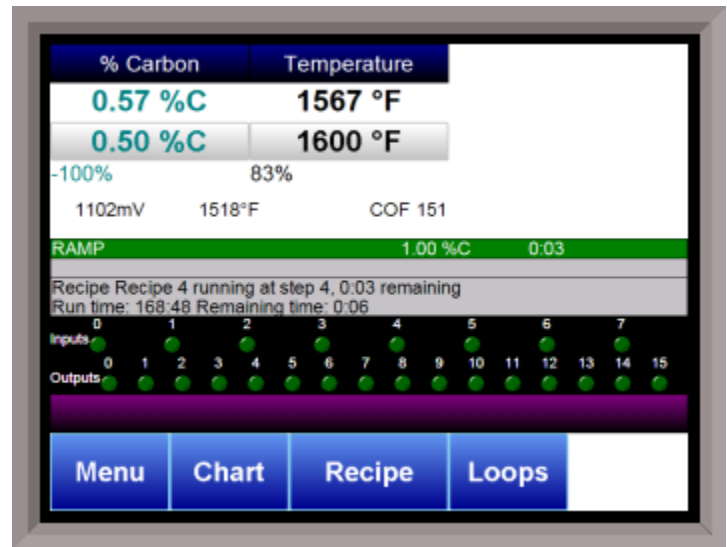

Menu

There are three levels of menus in the Series 9010.

- The first level is the *operator level*. These are functions or operations that are typically handled by the furnace operator. This menu is accessed without the need for a pass code.
- The second level is the *supervisor level*. This level requires the entry of a level 1 or a level 2-pass code.
- The third level is the *administrator level*. This requires the level 2-pass code ONLY.

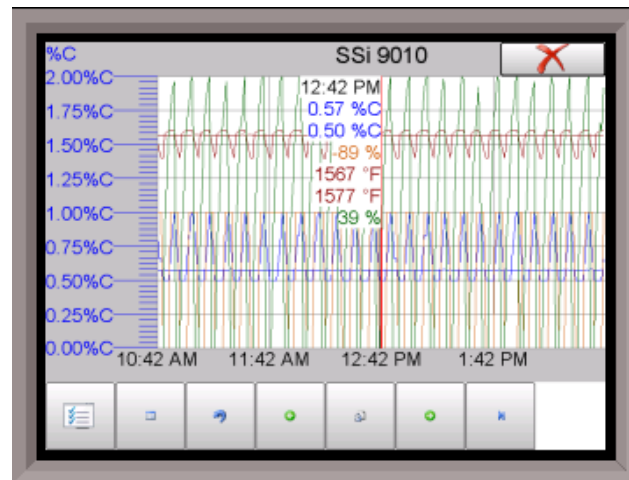

As shipped, the *supervisor* and *administrator* level codes are set as 1 and 2 respectively. The pass codes can be changed at the Passcode and Alarm Screen. *Note: Any level can access a lower level screen. For instance, the Administrator level passcode can access all of the Supervisor and Operator level screens.*

The menu items are explained in detail in *Chapter 3 – Configuration.*

Chart

The Chart Display shows between 1 hour and 24 hours of process variable data on the screen and can be scrolled back to view all of the data stored on the hard drive. The vertical timelines change as the time changes on the screen. Any trend charts that have been created through the Configuration menu are accessible here. See the *Chapter 2 – Configuration* section for more information on creating trend charts.

The function buttons run along the bottom of the screen.



The Trend Lines button -  - will allow the user to select or de-select the trend lines on the trend chart to display. If the checkbox next to each trend line is checked, then that trend line will be displayed.



The Datagrid View button -  - will display a screen with the trend data in a grid format instead of with trend lines. The trend data is shown in 1-minute intervals. Clicking on the **OK** button on this screen will close the screen down and return to the Chart Display screen.



The Refresh button -  - will refresh the screen's trend data if the screen is not in real-time mode.



The left-pointing green arrow button -  - will move the chart's view backward in time by the specified chart interval.



The chart interval button -  - will determine the number of hours displayed on the trend chart. The options are: **1 Hour, 2 Hours, 4 Hours, 8 Hours, 12 Hours, or 24 Hours.**



The right-pointing green arrow button -  - will move the chart's view forward in time by the specified chart interval.



The right-pointing arrow with the vertical line next to it button -  - will put the chart into real-time mode if it is not in real-time mode, or take the chart out of real-time mode if it is. When in real-time mode, the chart will automatically be updated once a minute.

Chart Sub Menu

There is a sub-menu available by putting a finger or a stylus anywhere on the chart and holding it there for a couple of seconds. The sub-menu will have the following options available: **Zoom, Restore, Add Note, Data, and Exit.**



The **Zoom** option will allow the user to zoom in on a particular part of the screen. Once this has been selected, the user can take a stylus or a finger and create a box around the desired data. Once the user releases the stylus or finger, a zoom is no longer possible, and the user will need to re-select the option from the sub-menu to zoom in again.

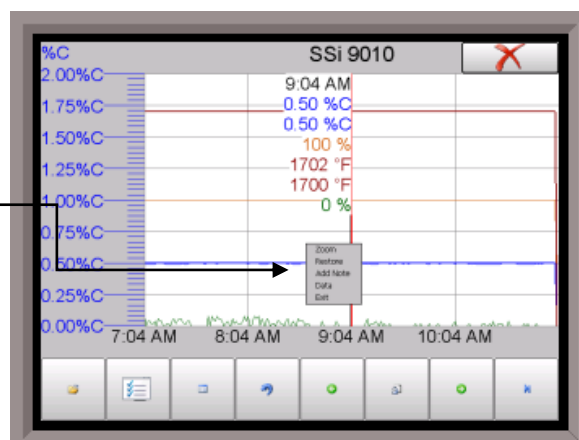
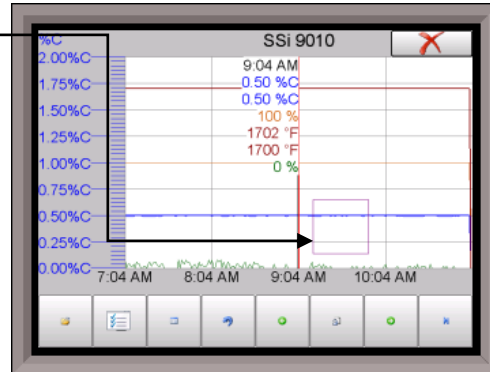

The **Restore** option will back out of any zoom options that have been performed and display the chart screen as it initially was.

The **Add Note** option allows the operator to enter a note on the chart, similar to writing on a paper chart. The note shows up when the chart is printed out using the utility software included with the Series 9010 instrumentation. Pressing the **Add Note** option displays a screen where the operator can enter the operator ID or initials and a note. The user has the option to enter a note using the operator interface keyboard, where he or she will be able to type in the note; or the user can use the Signature mode, which will allow them to write a note using a stylus.

The **Data** option will show the trend data as a data grid instead of the trend lines on a chart. This



functionality is exactly the same as if the user pressed the Datagrid View button - from the chart screen.

Some chart display settings are configurable – see the Configuration Menu section for details.

Exit will close out the sub-menu without selecting an item.

Pressing the red 'X' in the top right-hand corner of the screen will take the user back to the status screen.

Recipe

Advance	Hold	Stop	Soak
1 - SETPT	1400 °F	0.50 %C	
2 - DELAY			5 sec
3 - RAMP	1600 °F		0:03
4 - RAMP		1.00 %C	0:03
5 - RAMP	1400 °F	0.50 %C	0:03
6 - BRANCH	1	1	
7 - NO-OP			
8 - NO-OP			
9 - NO-OP			
10 - NO-OP			
11 - NO-OP			
12 - NO-OP			

Recipe Recipe 4 running at step 4, 0:02 remaining
Run time: 168:30 Remaining time: 0:05

Quick Load Load Return

Pressing the **Recipe** button on the main status screen displays the recipe screen, which will allow the user to load up an existing recipe and start it or see the recipe that is currently running.

The recipe screen shows the last program loaded into the program run buffer and its status. If the program is running, the active step number is highlighted green. When the step is highlighted green, then the recipe is running on that step. When a step is highlighted yellow, the recipe is in hold on that step. A red **Acknowledge** button in the bottom left corner of the screen displays an alarm condition. *Note – The*

Acknowledge button is only visible when an alarm condition is present. Once the condition is acknowledged, the **Acknowledge** button will become invisible again. The main status screen will also show the recipe running status as well as run time and remaining time for the current step and the entire recipe.

The recipe screen has a total of seven buttons that will allow the user to load a recipe, control the recipe and acknowledge an alarm.

- The **Advance** button will advance the recipe to the next step in the recipe. The user will need to confirm the advance command.
- The **Hold** button places the displayed recipe program in hold. Once a decision is made that affects the recipe, it may be continued by pressing the **Resume** button. *Note – When a recipe is put into hold status, the text on the **Hold** button will change to “Resume”. When the step is started up again, the text on the button will change back to “Hold”.* When a recipe step is in a hold status, the step will be highlighted yellow. The user will need to confirm the hold or resume command.
- The **Stop** button stops the recipe program that is currently running. Stop means exactly that! It stops the program. It is NOT a hold button. See the description for the hold button above. To re-start the program if it has been stopped you must use the **Load** button, enter the recipe number, and then highlight the segment number of the recipe that you want to start with and start the recipe again. The user will need to confirm the stop command.
- The **Soak** button allows you to enter a new value for the time remaining in the current soak or ramp cycle only – future soak or ramp cycle times cannot be modified. The step must be a soak or ramp cycle for a change in soak/ramp time to be adjusted.
- The **Acknowledge** button will acknowledge the alarm. In most cases, it will be acknowledging *end of soak*. The alarm must be acknowledged to allow the program to go to the next step. *Note – The **Acknowledge** button is only visible when an alarm condition is present. Once the condition is acknowledged, the **Acknowledge** button will become invisible again.*
- The **Load** button allows the operator to enter the recipe number to be run and to view the recipe before pushing the **Run** button. Pushing the **Run** button starts the recipe. If a recipe program is running and the operator enters a new recipe program it can be viewed and modified. The recipe does not become active until the **Run** button is pushed. Pressing **Run** places the program currently being viewed in the active memory and will begin to run the

Step	1	Step	1
1 - SETPT	1700 °F	wait	
2 - SETPT	1700 °F 1.00 %C	wait	
3 - SOAK	0:01		
4 - EVT_OUT	3-ON		
5 - SETPT	1600 °F	wait	
6 - DELAY	5 sec		
7 - EVT_OUT	3-OFF		
8 - SETPT	1600 °F 0.80 %C	wait	
9 - SOAK	0:01		
10 - EVT_OUT	COOL-ON		
11 - ALARM	End Cycle		
12 - EVT_OUT	COOL-OFF		

new recipe. To select the recipe to view or edit, click on the recipe number button in the top left corner of the screen. This will display a screen where the user will be able to load up a valid recipe (range 1 – 300). The program can be started in any step by clicking on the step number button next to the “Step” text and entering the new step

Opcode: G_SOAK Temp: [dropdown]
 Alphabetical
 Wait limit: [0] : [5] : [2] : [15]
 Disable
 OK Cancel

number (range 1 – 12), and then pressing the **Run** key.

While reviewing the program that is about to be run, each step can be modified. Highlight a step number and click on the **Edit** button. The opcode can be changed with the drop down list at the top. This list can be sorted alphabetically by click on the “Alphabetical” checkbox. The parameters of the opcode can be modified on this screen as well. See the *Chapter 4 – SERIES 9010 Opcodes* section for details about each opcode. Click on the **OK** button to accept the changes; click on the **Cancel** button to ignore the changes. *Note – Any change to the recipe is a one-time edit, and will not affect the recipe that is saved on the 9010 controller.* Click on the **Cancel** button on the Load Recipe screen to cancel loading a recipe and return to the main recipe screen.

- The **Return** button returns you to the main status screen.

Loops

The current process variable is displayed at the top, with each loop set point displayed beneath the process variable. The operator can change the process set point by touching the screen area below the large process variable numbers. When pressing the Temperature or % Carbon set point a numeric keypad is displayed, showing the current value and allowing you to enter a new set point by simply pressing on the appropriate numeric keys. Once the correct set point has been entered, press the **OK** key to make the change. When the **OK** key is pressed the display returns to the Loops Screen.



Also displayed are the probe millivolts, the probe temperature, and the CO Factor. The CO Factor can also be adjusted from this screen. After pushing the **COF** button a numeric screen pad pops up and allows the authorized personnel to make the appropriate change.

COF is the sole adjustable variable that can be used to influence the calculated carbon potential; with other parameters (Probe mV and Temperature) being fixed. As such COF can be increased/decreased to compensate for differences with a furnace, atmosphere composition, etc. The table below shows how changes to COF will result in different calculated carbon potentials.

Note: Default COF is set to 200.

COF	Probe mV	Probe Temp	Carbon
190	1100 mV	1700°F	0.44
200	1100 mV	1700°F	0.46
210	1100 mV	1700°F	0.48

This example assumes a controller atmosphere set point of 0.46%*c*. By decreasing the COF to 190, the calculated carbon potential is lowered from 0.46- to 0.44%*c*. As such the furnace's control system will respond by increasing the volume of enrichment gas to return the atmosphere to equilibrium of 0.46%*c*. Contrary by increasing the COF to 210, the calculated carbon potential is increased from 0.46- to 0.48%*c*. As such the furnace's control system will respond by increasing the volume of dilution air to return the atmosphere to equilibrium of 0.46%*c*.

The Loops Screen also allows you to move back to the Status Screen or to the Recipe Screen by pressing the **Recipe** button to view the program currently running on the Series 9010 controller.

The following options allow the user to customize and monitor the operation of the Series 9010 controller.

Logs

The Logs screen will allow the user to view three different types of logs – **System**, **Alarms**, and **Cycle**. Clicking on the button that displays the log type (**System Log**, **Alarm Log**, or **Cycle Log**) will allow the user to select the type of log file to view.

The green directional arrows will display the previous items in the log or the next items in the log, if the log items are longer than one screen. The drop down list in between the directional arrows will allow the user to select the date of the log items to view.

The **Return** button will return the user to the menu screen.

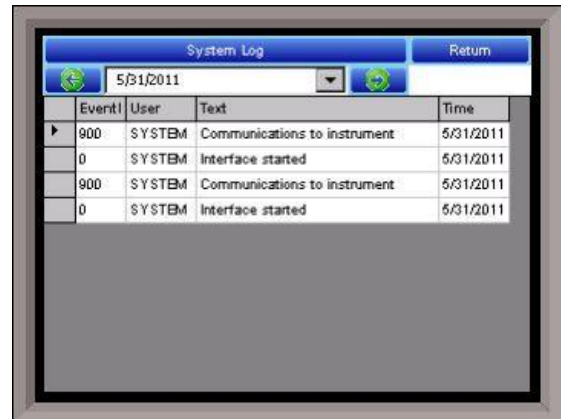

Slave Communications Status

This page is a display of the current process variables of each of the auxiliary instruments communicating with the controller. These values are display-only, and cannot be modified from this screen.

There are five possible messages that can occur to describe the instrument communications status.

- N/A – No instrument is connected
- Bad – No communications exist
- ??? – Communications exist, but there are frequent errors
- ?OK – Communications exist, but there are occasional errors
- OK – Communication is established and working properly

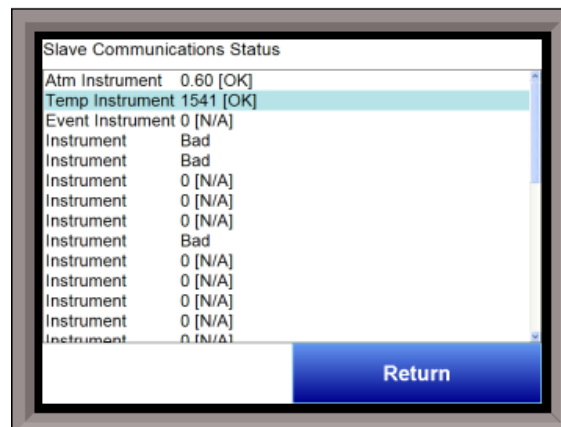

For set-up of the auxiliary instruments go to the menu item “*Slave Instrument Setup*”
 The **Return** button will return the user to the menu screen.

Auxiliary Analog Input

This menu option shows the process variables for the 3 analog inputs of the 9010 dual loop controller. It also shows the input types and any information from attached slave analog input modules. *Note – None of these values can be modified on this screen.*

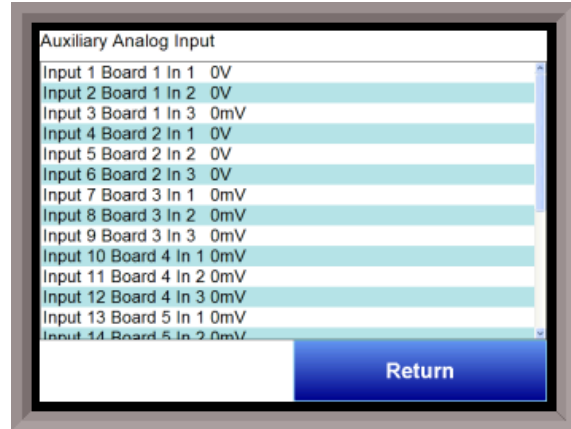

Manual Event Control



The Manual Event Control menu option shows the user all of the events (0 – 15) and their current status. It also allows the user to manually control the status of any event by clicking on the value. To change the status, highlight the specific event and click on the **Edit** button. The user will be able to select either an **On** value or an **Off** value. Clicking on the **OK** button will set the value, while clicking on the **Cancel** button will cancel the action. The **Return** button will return the user to the menu screen.

Shutdown

The Shutdown selection will display a screen asking whether or not to shutdown the interface of the Series 9010. When the operator interface is shutdown, the SERIES 9010 controller is still functioning. IT can be monitored by connecting the ETHERNET connection to a laptop computer, using Internet Explorer, and assigning a legitimate IP address. Choosing **Yes** displays a typical computer desktop screen with the **Start** button in the bottom left-hand corner. The power to the operator interface can now be turned off without upsetting any of the settings. Choosing **No** displays the initial Status Screen. *Note -Shutting down the Operator Interface does not shutdown the Series 9010 Controller.*

Recipe Edit

This option will allow the user to edit a recipe that is stored on the controller.

The **Load** button will allow the user to select which recipe to load. Once the recipe has been selected, the recipe will be displayed on the screen.

The higher recipe steps can be viewed by holding a finger or stylus on the screen and scrolling up or down.

To edit a specific step, highlight that step and press the **Edit** button. This will allow the user to select a different Opcode to use, or to change the information entered for the current Opcode. See the *Chapter 4 – SERIES 9010 Opcodes* section for more information on each Opcode and their purpose.

To insert a step into the program, highlight the step number for the step, and press the **Insert** button. The user will have to confirm the insert. Once this has been confirmed, the user will be able to select the Opcode to use. *Note – Inserting a step will push every step after down one, so an Opcode at step 24 will be lost.*

To remove a step from the recipe, highlight the step number to remove, and press the **Delete** button. The user will have to confirm the delete. Once the delete has been confirmed, the step will be deleted and every step after will be moved up one step. Blank step numbers will be replaced with a NO-OP Opcode. Press the **Save** button to save the changes that have been made. The recipe can be saved as any valid recipe number. If the desired recipe number already contains a recipe, the user will have to confirm the save before the old recipe will be overwritten.

If the user wishes to delete an entire recipe, there are two options. First, the desired recipe can be loaded and each step can be changed to the NO-OP Opcode then saved. Or, the 24-step “blank” (NO-OP) program that is loaded when the *Recipe Edit* screen is first displayed as the desired program number can be saved. This will save the “blank” recipe to the desired recipe number location.

The **Return** button will return the user to the menu screen.

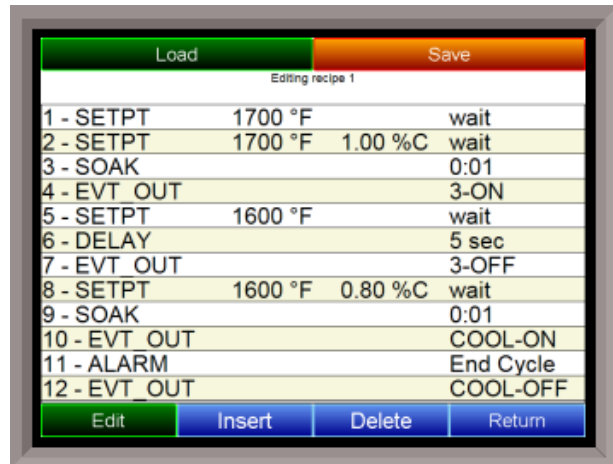

Load T/C Configuration

Configuration of any analog input device must be completed under this menu item.

Load TC Enable

This value will manually toggle between **on**, **on + alarms**, and **off**.

On – T/C Enabled

On + Alarms – T/C Enabled, Programmer alarm114 provided if out of band (Default wait limits)

Off – T/C not enabled

Control TC

This value allows the user to set the TC to be part of the group of Load TCs that can hold the program if it is out of band. The values are **active** or **not active** (shown as blank).

TC 1 – 24

This value allows the user to manually turn the T/C from **active** to **not active**, shown as blank, to be part of

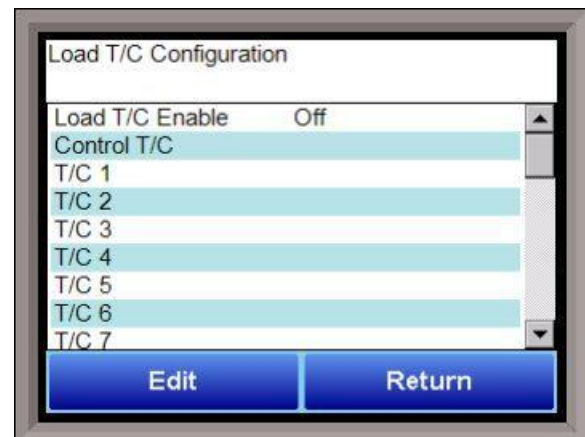

the group of TCs that can hold the program if it's out of band. TC 28 – TC 30 correspond to Analog Input 1 – Analog Input 3. The values are **active** or **not active** (shown as blank).

Load T/C Alm On Delay (Sec)

This option will allow the user to set a delay time, in seconds, before the load T/C alarm is activated. The range is **0 – 32767**.

The **Return** button will return the user to the menu screen.

Trend Chart Edit

This menu option will allow the user to add, modify, or delete trend lines in a trend chart file, as well as the trend chart files themselves. The trend lines are the number of variables displayed on one screen. For example this could be a control, overtemp, or load thermocouple on a batch furnace. Or it could be one thermocouple from eight temper furnaces. There is not a maximum for template selections, but the number of variables displayed on one screen must be a consideration in this process. The buttons across the top of the screen – **Open, New, Delete, Save, and Save As** – deal with the trend chart files themselves, not the individual trend lines.

Open will allow the user to select a trend chart file to open up to edit.

New will create a new trend chart file where trend lines can be added.

Delete will delete a specified trend chart file.

Save will save all changes to the current trend chart file that have been made.

Save As will allow the user to save the current trend chart file as a new file with a different name.

The screenshot shows a menu titled 'Trend Chart Edit' with the following options:

- Name: Temp ACT
- Data: Temperature
- Min: 0, Max: 2000
- Expression: x
- Format: 0
- Units: °F
- Line Width: 1
- Sample: Test Result
- Buttons: Set, Cancel

Once a new trend chart file has been created, or one has been opened, trend lines can be added, modified, or deleted. **Add** will add a new trend line to the file. **Edit** will allow the user to edit the information for a specific trend line. **Delete Line** will delete the specified line from the chart file.

Adding or editing a trend line will involve the following parameters:

Name – the name of the input, for example “Temp ACT” which would be the actual temperature of the input. It is a good idea to shorten the names so that they still make sense, but do not take up as much space.

Data – This will determine where the data is coming from. The user can click on the box to select from the list of data logged points in the 9010. Some of the points have a name, such as “Temperature” or “Temperature SP”, but others will just show the register in the 9010 that has been logged.

Min – the minimum displayed scale value on a chart.

Max – the maximum displayed scale value on a chart.

Expression – every input requires an expression to be calculated and displayed correctly. This is because the registers in the 9010 hold only integer values, so any value that requires a decimal point needs to be set up properly for the display. For example an expression for temperature would be x (1750 = 1750). For a value such as carbon or millivolts, the expression would be $x * 0.01$ (150 = 1.50) or $x * 0.1$ (805 = 80.5).

Format – the value displayed on the chart display of the operator interface. A short custom description can be added here. For example, to display one (1) decimal point, enter a value of “#0.0”. For carbon values, enter a value of “#0.00” for 2 decimals. This would display a value like “0.81”. Entering “#.00” would display a value of “.81”. #0 or 0 will display integer values.

Color – The box next to the format box will allow the user to apply a color to the trend line to differentiate it from other trend lines on the chart.

Units – The type of units used for the trend.

Line Width – a numeric value for the thickness of the trend line. A 1 is a thin line; A higher value = thicker line width.

Sample – a number is entered here to test the expression and verify that formatting is correct.

Test – Press the test button to calculate the expression with the value entered in the sample parameter. For example with an expression of $x*.1$ and a value of 250 entered in the sample parameter will display a 25.0.

The **Set** button will set the values entered. The **Cancel** button will cancel the information and make no changes.

The **OK** button will close down the screen and prompt the user to save any changes if changes have been made.

The **Cancel** button will close down the screen and return to the menu screen.

Communications Setup

Warning: Changes to this screen should not be made without consulting SSI at 513-772-0060.

IP Address

NOTE: These screen options are for changing *the controller's IP address, Mask, and Gateway*. If you need to change the *IP address of the Touch Screen*, see the instructions in Appendix A of the Touch Screen Manager manual, available at www.supersystems.com.

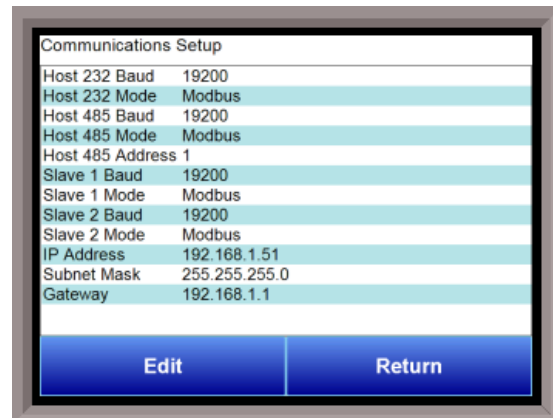

To change the IP Address, Subnet Mask, or Gateway, highlight the parameter that needs to be entered and press the **Edit** key to displays a numeric keypad that can be used to enter the required value. Pressing the **Return** key returns you to the Configuration Menu.

The default IP Address is: 192.168.0.200

The default IP Address Gateway is: 192.168.1.1

Instrument Assignments

WARNING: This screen should not be changed without consulting SSI at 513-772-0060.

This screen will allow the user to configure up to thirty-two slave instruments through the 9010 controller. To set up a slave instrument, highlight the instrument number and click on the **Edit** button. The list of available slave instruments will be shown on the screen. The list is color coded by type – Blue for Atmosphere, Red for Temperature, and Yellow for Events. Highlight an instrument to select it as the instrument to use.

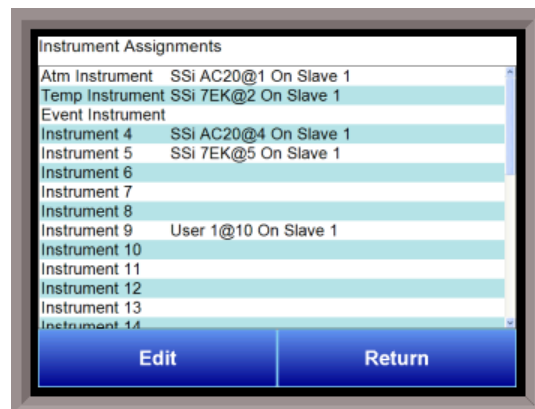

The list of controllers includes the following Atmosphere Controllers:

- **SSi AC20**

- Yokogawa 750
- Honeywell UDC3300
- Dualpro LP1 Modbus
- Dualpro LP2 Modbus
- Dualpro LP1 MMI
- Dualpro LP2 MMI
- Eurotherm 2402
- Eurotherm 2500
- Carbpro v3.5
- Carbpro v3.0
- CarbPC
- 9200 Loop 1
- IR Base
- MGA

This list of controllers includes the following Temperature Controllers:

- SSi 7EK
- Yokogawa 750
- Honeywell UDC3300
- Dualpro LP1 Modbus
- Dualpro LP2 Modbus
- Dualpro LP1 MMI
- Dualpro LP2 MMI
- Eurotherm 2402
- Eurotherm 2500
- Unipro v3.5
- Unipro v3.0
- Carbpro v3.5 Slave
- Carbpro v3.0 Slave
- 10Pro
- DualPro IN C
- 9200 LP1
- 9200 LP2
- 9200 LP3
- 9100 LP2
- Eurotherm 2704 lp1
- Eurotherm 2704 lp2
- Eurotherm 2704 lp3
- VC BASE 1
- VC BASE 2
- VC BASE 3
- VC BASE 4
- AIPC
- SSi 7SL
- AEC Flow Board
- UMC800 Lp1
- SSi Quad A01
- SSi Quad A02
- SSi Quad A03
- SSi Quad A04
- Yokogawa UT350
- Yokogawa 750 Lp 2

- Yokogawa UP350
- Honeywell DCP551
- Ascon 08

This list of controllers includes the following Event Controllers:

- SSi AC E
- Yokogawa 750E
- Mod Mux
- Dualpro E Modbus
- Dualpro E MMI
- Carbpro E v3.5
- Carbpro E v3.0
- Eurotherm 2500
- SSi 8-8
- SSi 9200E
- Micrologix PLC
- MCM Module
- PLC5 DF1
- SLC DF1

The number below the list is the address for the slave instrument. The range 0 – 255.

**** All devices on the same slave port must utilize the same protocol**

**** An address of zero (0) will disable the instrument**** Some controllers (AC20 for example) can provide dual functions (atmosphere and events) and must have the same address assigned for both.

The slave port is next to the address. The Slave port option can be: **Slave 1, Slave 2, Slave 3, or RS-232.**

The **OK** button will set the slave instrument, and the **Cancel** button will cancel the setup.

The **Return** button will return the user to the menu screen.

Zone Assignments

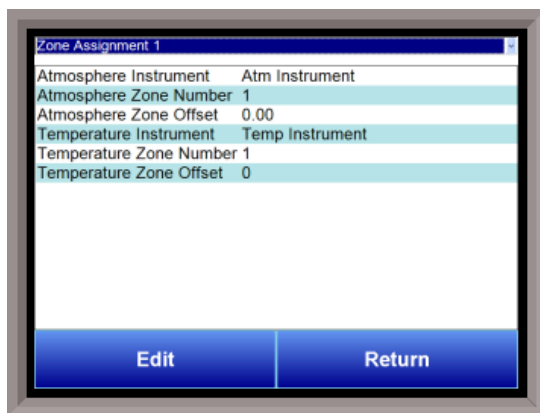

WARNING: This screen should not be changed without consulting SSi at 513-772-0060.

The zone assignment feature allows the Series 9010 program to change set points on all instruments of a multi-zone furnace. The Series 9010 has temperature and atmosphere zone assignments for up to 5 zones. The Series 9010 programmer looks for appropriate zone assignments whenever a set point is to be sent to the atmosphere or temperature controller. The temperature set point is sent to every instrument number in the

temperature zone assignment.

If the *ZONE_OFF* opcode had been used in the program the set point sent to the specified zone instrument will have the offset added. For example, assume a 4-zone pit furnace where the bottom zone usually has a lower set point, then the middle zones and the top zone usually has a higher set point. The bottom zone temperature controller is assigned to zone 1, the middle temperature controllers to zones 2 and 3, and the top zone controller to zone 4.

If the first three steps of a program are as shown below, then the bottom zone set point is 1725, the middle zones are 1750, and the top zone is 1800.

Step	opcode	Temperature	Atmosphere	Option
1	<i>ZONE_OFF</i>	-25		1
2	<i>ZONE_OFF</i>	50		4
3	<i>SETPT</i>	1750		

The first step sets the offset for zone 1 to -25 degrees; therefore, the bottom zone controller would be sent a set point of 1725 when step 3 is executed. Likewise step 2 sets the offset for zone 4 to 50 degrees. The top zone then receives a set point of 1800. The middle zone controller would receive the 1750. The temperature controller displayed on the status display is instrument #2. If instrument #2 was the top zone controller then the Status Display would show the 1800-degree set point.

When using the multi-zone offset feature, the atmosphere and temperature controller assigned as instruments 1 and 2 should be in zones that will not be offset.

Furnace Setup

This option allows for several furnace features to be customized.

Programmer Type

The five options within programmer type are **Carbon**, **Dewpoint**, **Oxygen**, **Millivolts**, and **Multiloop**. Select the appropriate choice to communicate to the controller the type of condition it is currently running. **Multiloop** applies to temperature only. The operator will need to change the control instrument (such as the AC20) accordingly.

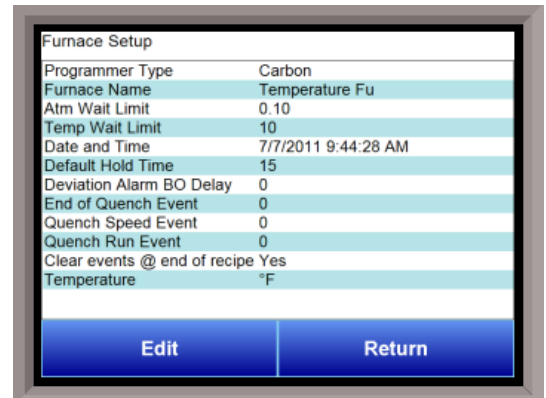

Furnace Name

This allows the operator to assign a name to the furnace by typing it in and pressing **enter**.

Atm Wait Limit

When an atmosphere wait-limit is assigned, the recipe running will not move to the next step until the furnace has reached the target carbon percentage.

Temp Wait Limit

When a temperature wait limit is assigned, the recipe running will not move to the next step until the furnace has reached the target temperature.

Date and Time

This will adjust the date and time of the controller, but not the actual operator interface. The date and time of the operator interface can be changed by going to through the desktop.

Default Hold Time

This allows the operator to put a hold on the current recipe running. The recipe will stay on hold for the duration of the default hold time if the operator does not advance the recipe. When the default hold period is up, an alarm will sound.

Deviation Alarm Delay

This value is the delay for the alarm in minutes if a deviation alarm is detected.

End of Quench Event

This option allows the operator to assign an event to signal when the quench is over.

Quench Speed Event

This option allows the operator to assign an event that will signal the speed the quench.

Quench Run Event

This event will signal the start of the quench.

Clear events @ end of recipe

The operator can choose either **yes** or **no**. If **no** is selected, then events will stay on after the recipe is finished. For instance, if one of the events turns a light on during the recipe, this light will remain lit until the operator manually turns it off if events are not cleared at the end of the recipe.

Temperature

This allows the operator to choose either C° or F° as the units for temperature.

Security

The Security menu option is a feature that is used to limit access to certain menu options and parameters that are vital to successful operation and communication of your instrument. This page comes pre-configured by Super Systems Inc. and should not be adjusted without consulting SSI. The options are **operator**, **supervisor**, or **administrator**.

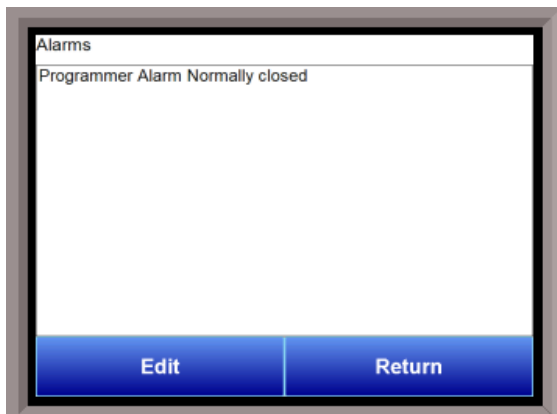
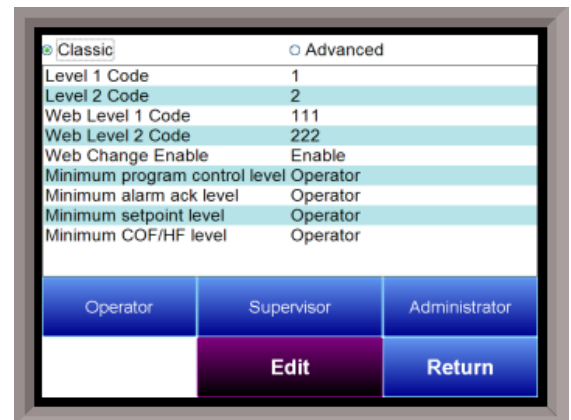

Alarms

The 9010 controller *Alarms* screen allows the operator to change the state of the programmer alarm. To make a change, select the **Programmer Alarm Normally** button, press **Edit**, and the status can be changed to either **Normally closed** or **Normally open**.

Event Hold/Reset

The Event Hold/Reset menu option provides the user manual control of the operation based upon process information. This will allow the setup of the digital inputs so that if a recipe needs to run only under a specific condition, the condition can be based off of an event input from a digital input through a switch. It can be setup to run if the input is active or inactive. This can also be based off of the relay contacts N.O./N.C. This is useful when testing wiring and field devices.

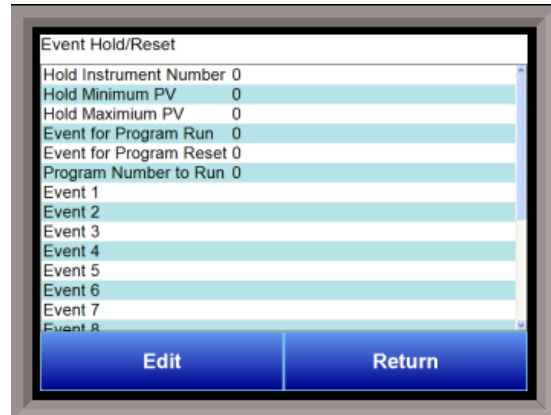

Hold Instrument Number

Clicking on this value will display an input box from which the user can select a new value. The range is **0** to **25**.

Hold Minimum PV

Clicking on this value will display an input box from which the user can select a minimum PV that would cause the recipe to hold if below this new value. The range is -**32768** to **32767**.

Hold Maximum PV

Clicking on this value will display an input box from which the user can select a maximum PV that would cause the recipe to hold if above this new value. The range is -**32768** to **32767**.

Event for Program Run

Clicking on this value will display an input box from which the user can select an event input that would cause the recipe to run based upon this new value. The recipe number to run can be selected under the Program Number to Run option. This will allow a single program not a variable. The range is **-1** (Disable) to **15**.

Event for Program Reset

Clicking on this value will display an input box from which the user can select an event input that would cause the recipe to reset based upon this new value. The range is **-1** (Disable) to **15**.

Program Number to Run

This is the recipe number to run. The range is: **0** – **300**.

Event 0 Through Event 16

The input box for these events has two drop-down lists. The top list contains **Active** and **Inactive**. When active is selected, this means that the digital input is now activated. The bottom list contains **Closed** and **Open**. This will determine how the inputs work based off of an open contact or no input and a closed contact having a digital input made.

The **Return** button will return the user to the menu screen.

Aux Analog Input Setup

The Auxiliary Analog Input Setup displays the instruments slaved to the Series 9010 and their process variables. This is where the input type for the slaved analog input board can be setup and if needed a correction curved used. This section will also allow you to calibrate the analog input board that is selected in the drop down menu above.

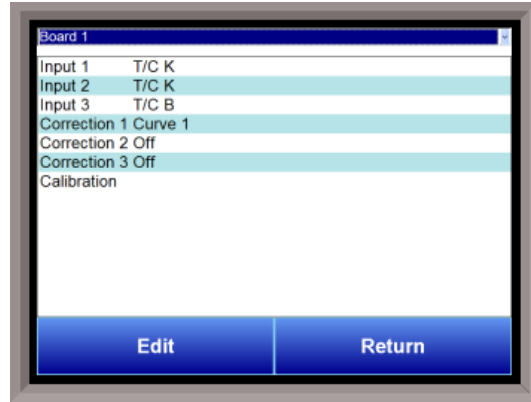

Configuration

This option will allow the user to set some general configuration settings. The list of configurable items is:

- **Log Maintenance**
- **Alarm Text**
- **Event Text**
- **Compact Database**
- **Screen Communications**
- **Datalogging Setup**
- **Appearance**
- **Recipe Configuration**
- **MiniBatch (If MiniBatch has been activated)**
- **Product Activation**
- **Repair Database**
- **Time Synchronization**
- **Backup/Restore**
- **Read/Write Data**
- **Language**
- **Load T/C Map**
- **Chart Settings**

Log Maintenance

This option will allow the user to purge, or delete, log files, starting from a specific date. All log files from on or before the selected date will be purged. The user can purge log files from the **Alarm Log**, **Event Log**, or **System Log**.

Alarm Text

This option will allow the user to modify the text for **Programmer Alarm 1 – Programmer Alarm 99**. Programmer alarms are internal, non-modifiable alarms that are triggered when there is a certain condition in the 9010 programmer. The text for the programmer alarms can be modified to more accurately describe these conditions. User Alarm 0 is not an alarm; it is used to turn off a user alarm. It functions the same way as the acknowledge button.

Event Text

This menu option will allow the user to configure the text for the input and output events for the 9010. Select whether to edit the Input events or the Output Events. *Note – The list of events can take a few seconds to load.* The screen will refresh after the list has been loaded. There are a total of 7 input events, and 15 output events. Highlight the event to be changed and click on the **Edit** button. This action will display the on-screen keyboard, which will allow the user to modify the event text. To save the

changes to the event text, click on the **Save** button. Clicking on the **Return** button will not save any of the changes made. *Note – Clicking on the **Save** button will not close the Edit Event Text screen.*

Compact Database

This menu option will automatically compact the DW9010DB.sdf database. This database will keep track of all of the alarms, events, recipes, and system events that occur on the 9010. When records are added, space is reserved in the database table for the maximum amount of characters, regardless of the actual number of characters in the record. Once the record is added, this space is not released. Instead, it will still be associated with the record, thereby adding to the total disk space and slowing down the communication time with the database. Compacting the database will free up this extra space, which will speed up the amount of time it takes the software to communicate with the database.

Screen Coms

This menu option will allow the user to determine how the Touchscreen will communicate with the 9010 instrument. The settings are based upon the DIP switch settings on the back of the screen. A 3.5" uses one connection. On a 5.7" screen comm1 = 232 and comm3 = 485. On a 12.1" screen comm1 = 232 and the port labeled 232/422/485 = 485.

The Media option will be the type of connection the Touchscreen is using to connect to the 9010. The options are:

- **COM1 = {232}**
- **COM2**
- **COM3**
- **COM4 = {485}**
- **Ethernet**

If COM1 through COM4 is selected, the user will have to set the Address and the Baud rate as well. If Ethernet is selected, then user will have to enter the IP address of the 9010 instrument.

The Address option is the slave address of the 9010 instrument for the COM port communications, or the Ethernet IP address for Ethernet communications. For the COM port communications, the address will range from 1 to 250. For Ethernet communications, the address must be supplied in a 999.999.999.999 format, or it will not be accepted.

The Baud option is the baud rate for the COM port communications. The options are:

- 1200
- 2400
- 4800
- 9600
- 14400
- 19200
- 28800
- 38400
- 57600
- 76800
- 115200

Datalogging Setup

Note – Contact Super Systems before making any changes on this screen, since any changes made can have an adverse effect on the data being displayed.

This menu option will allow the user to modify which registers in the 9010 will be used as datalog data. This list of data values is shown at the top of the screen.

Click on the **Add** button to add a new set of data values, or click on the **Edit** button to edit an existing set of data values. Click on the **Delete** button to delete a set of values. To add or edit data values, enter the initial offset of the register, as well as the number of sequential registers to read for. Clicking on the **Save** button will save the new data value registers. *Note – The **Save** button must be clicked on to save any changes to the datalog data, including resetting the configuration.* Clicking on the **Cancel** button will cancel the action. Clicking on the **Reset** button will reset the values to the original configuration. *Note – any changes made to the data values will need a restart of the application before those changes will take effect.* Clicking on the **Descriptions** button will display any descriptions for the data values. The default description for a data value is the data value’s register. So the default description for data value 25007 is “25007”. Changing this to “Temperature”, for example, would make it more descriptive. Register 25007 holds the actual temperature value for the 9010.

To add a new description, click on the **Add** button. To insert a new description, click on the **Insert** button. To delete a description, click on the **Delete** button. To edit an existing description, click on the **Edit** button. The Add or Insert feature will only create valid descriptions if there are existing data values without descriptions. Click on the **OK** button to save the description changes. Click on the **Return** button to cancel any changes and return to the previous screen.

Appearance

This option allows the user to assign Custom Text to Loops 1 and 2 for the touchscreen display interface. Select the appropriate blue box to enter custom text.



Recipe Configuration

Using this screen, operators can give names to recipes for easy access. The operator must first choose “Recipes on device access by name” from the drop down menu. Next, select the Maintain Recipes button. This screen will allow the operator to Edit and name recipes. Recipes can then be found by name under Recipe Edit.

Each recipe name must be set up with a recipe number in order to be viewable in SSI Configurator. If recipes are set up by name only in Recipe Configuration, you will not be able to view these recipes in SSI Configurator.

The Compact Database button will compact the mb.sdf database file that is located on the Touchscreen. When records are added, space is reserved in the database table for the maximum amount of characters, regardless of the actual number of characters in the record. Once the record is added, this space is not released. Instead, it will still be associated with the record, thereby adding to the total disk space and slowing down the communication time with the database. Compacting the database will free up this extra space, which will speed up the amount of time it takes the software to communicate with the database.

MiniBatch

When MiniBatch is activated, the setup for each of the parts – **Maintain Recipes**, **Maintain Parts**, **Maintain Users**, and **Administration** – can be accessed through the “Configuration” menu. At least one recipe, part, and user must be set up before MiniBatch can be used through the 9010 Touchscreen. *Note – When MiniBatch is not activated, this menu option will be hidden, and the **Recipe Configuration** option will be visible.*

See the section *Appendix C – Using MiniBatch with the 9010 Touchscreen* for instructions.

Product Activation

This option will allow the user to activate the MiniBatch application for the 9010 controller. An activation code will be required to activate the software. Once MiniBatch has been activated, the **MiniBatch** button will be visible on the main Configuration screen. MiniBatch can also be deactivated from this option.

Repair Database

This feature will make attempted repairs on all SQL databases associated with the screen. Clicking the Repair Database button will display a timer icon while the repair is taking place.

Time Synchronization

This option allows the user to set up the touch screen to sync the system time with an Internet-based time server.

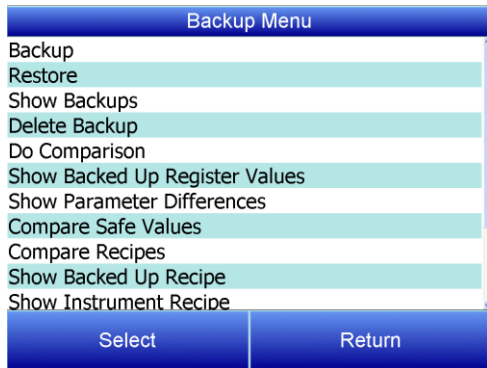

Backup/Restore

This option allows users to create and restore backups, and provides the ability to change backup settings.

Note: Backups are stored in a SQL database under the DW9010 folder. The default filename is *Backups9010.sdf*

The Backup Menu contains the following options:

Backup

The 9010 Backup feature is set to a default of 300, meaning that 300 recipes will be backed up. This number can be adjusted (e.g. if fewer recipes are being used and a faster backup is needed). To do so, tap "Recipes to Back Up" and then tap "Edit."



NOTE: Only recipes that are backed up will be used for comparison or restore. For example, if 10 recipes are backed up, then recipes 11-300 will not be processed.

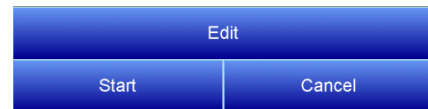

Tap "Start" to begin the backup.

The 9010 will display progress updates as the backup proceeds. Tap “Stop Backup” to stop the backup at any time. When the backup is complete, tap “Close.”

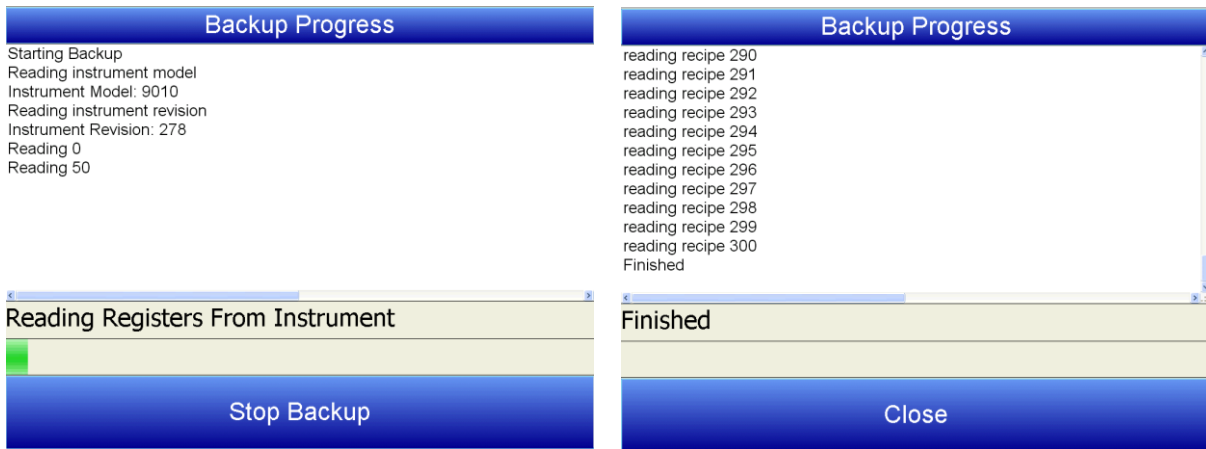

Restore

“Restore” will restore a backup to the connected instrument.

Select “Recipes to Restore” and tap “Edit” to change the number of recipes if necessary.

By default, the 9010 will preselect the *oldest* backup along with 300 recipes. To restore a different backup, tap the “Backup ID” and then tap “Edit.”

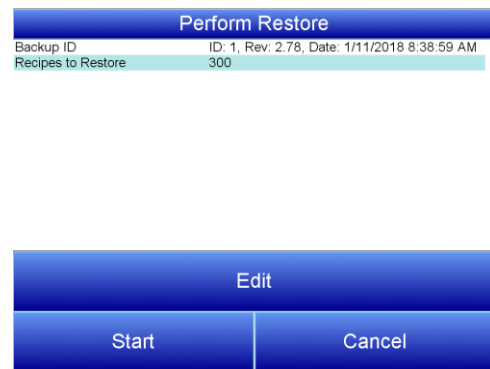

Backups will be ordered from most recent to oldest. By default, the last week of backups will be displayed. To adjust this, use the date buttons at the top of the list to adjust the From/To parameters.

Tap a backup and then tap “Show Detail” to see additional information about the selected backup (for additional information, see the “Show Backups” section below). Tap “Select” when the desired backup has been chosen.



Once the desired backup has been selected and the “Perform Restore” is again displayed, tap “Start” to restore the backup to the 9010.

NOTE:

- The restore routine will try to communicate with the 9010 as-is.
- If it receives no response it will attempt to communicate using COM1 (RS-232), 19200 baud and 250 Modbus address.

- If there is no answer on COM1, restore will try to communicate using COM2 (for 12.1" screens) or COM3 (for 5.7" screens), 19200 baud and 250 address.
- If there is no answer on the RS-485 port, restore will attempt to communicate using the settings from the backup (any port or ModbusTCP).
- If the 9010 doesn't answer the restore will stop and the message "Could not read, restore failed" is displayed.
- If communications are successful the restore process continues.

The progress of the restore will be displayed. When the restore is finished, tap "Close."

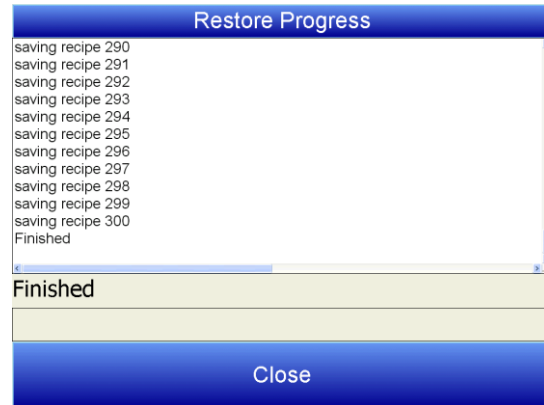

Show Backups

This feature allows the user to see and search the available backups and view detailed information on each.

Tap a backup and then tap "Show Detail" to see additional information about the selected backup.

Backups will be ordered from most recent to oldest. By default, the last week of backups will be displayed. To adjust this, use the date buttons at the top of the list to adjust the From/To parameters.

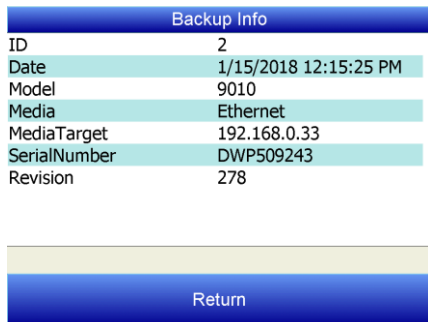

ID is the database's backup ID
Date is the date and time the backup was taken.
Model is the instrument model.
Media is the media used at the time of the backup (Serial or Ethernet)
MediaTarget is the target (IP address if Ethernet, Modbus address, com port and baud rate if serial).
SerialNumber is the serial number of the device
Revision is the firmware revision of the device.

Delete Backups

This feature allows the user to delete a backup from the database.

The selection process and navigation are the same as that found in the Show Backups menu. Once a backup is selected, tap "Select" to delete the backup. You will be asked to confirm your selection before the backup is deleted.

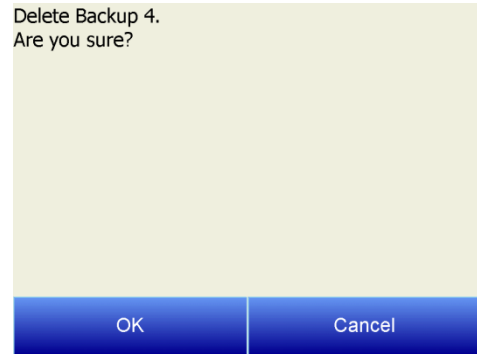

Do Comparison

This feature allows the user to compare two backups, or to compare a backup to the connected instrument.

NOTE: This feature compares configuration data only. It does not compare recipe data.

Tap the appropriate comparison type, then tap "Select."

If running the "Compare Instrument and Backup" option, backups on the ensuing selection screen will be ordered from most recent to oldest. By default, the last week of backups will be displayed. To adjust this, use the date buttons at the top of the list to adjust the From/To parameters.

Tap a backup and then tap "Show Detail" to see additional information about the selected backup. When ready to do a comparison, tap "Select."

A report will then be generated detailing the differences between the backup registers and the instrument.

If running the "Compare Two Backups" option, select a backup to be designated Backup ID 1, and another to be Backup ID 2, then tap "Start" to compare. A report will be generated detailing the differences between the two backups.

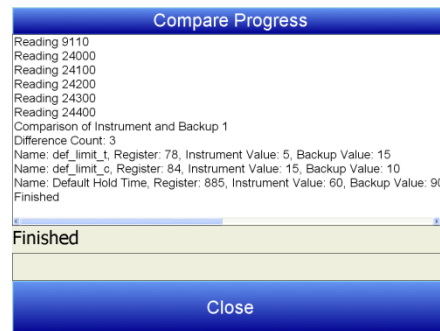
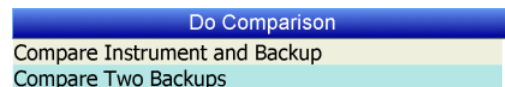

Show Backed Up Register Values

This feature allows the user to select a range of register values from a backup and display the corresponding value and description.

Show Range Register Values	
Backup ID	ID: 1, Rev: 2.78, Date: 1/15/2018 12:12:02 ...
Start Register	1
End register	1

Backups will be ordered from most recent to oldest. By default, the last week of backups will be displayed. To adjust this, use the date buttons at the top of the list to adjust the From/To parameters.

After selecting a backup, tap "Start Register" and then "Edit" to set the starting register for the report. Tap "End register" and "Edit" to set the ending register for the report. Tap "Start" when ready to begin.

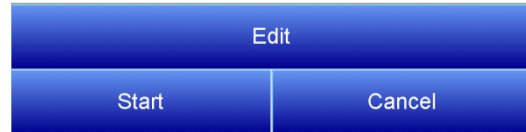

Show Parameter Differences

This feature allows the user to compare the valid parameters between two 9010 revisions and display the differences in a report.

Tap "Parameters in revision" and then "Edit" to set the first data source for the report. Tap "but not in revision" and "Edit" to set the second data source for the report. Tap "Start" when ready to begin.

In this example, the report will look for parameters that are in in revision 278, but not in revision 200:

Parameters Difference	
Parameters in revision	278
but not in revision	200

Show Registers Progress
PLC_type, start register: 11, register count 1
Pulse Meter Counter, start register: 50, register count 8
PLC Setups, start register: 801, register count 9
UTC Setups, start register: 820, register count 6
AIB Offset Enable, start register: 2059, register count 1
AIB Input Types, start register: 2060, register count 40
Instrument Calculation, start register: 5000, register count 1600
AIB Offset, start register: 9110, register count 40
Generic Instrument Data, start register: 24000, register count 200
Generic Instrument Map, start register: 24200, register count 200
Generic IP Data, start register: 24400, register count 80
Finished

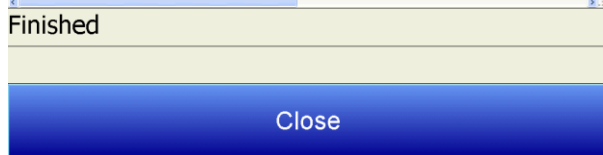

Compare Recipes

This feature allows the user to show the recipe numbers that differ between a backup and the instrument, or between two backups.

If running the “Compare Instrument and Backup Recipes” option, backups on the ensuing selection screen will be ordered from most recent to oldest. By default, the last week of backups will be displayed. To adjust this, use the date buttons at the top of the list to adjust the From/To parameters.

Tap a backup and then tap “Show Detail” to see additional information about the selected backup. When ready to do a comparison, tap “Select.”

Tap “First Recipe Number” and then “Edit” to set the first recipe number. Tap “Recipe Count” and “Edit” to set the number of recipes to compare. Tap “Start” when ready to begin.

If running the “Compare Two Backups” option, select a backup to be designated Backup ID 1, and another to be Backup ID 2. Tap “First Recipe Number” and then “Edit” to set the first recipe number. Tap “Recipe Count” and “Edit” to set the number of recipes to compare. Tap “Start” when ready to begin.

The report will show which recipes have been changed:

Compare Instrument and Backup Recipes	
Backup ID 1	ID: 1, Rev: 2.78, Date: 1/15/2018 12:12:02 ...
First Recipe Number	1
Recipe Count	300



Compare Instrument and Backup Recipes	
Backup ID 1	ID: 5, Rev: 2.78, Date: 1/15/2018 2:28:15 PM
Backup ID 2	ID: 1, Rev: 2.78, Date: 1/15/2018 12:12:02 ...
First Recipe Number	1
Recipe Count	300

Dialog box with title "Edit" and two buttons: "Start" and "Cancel".

Compare Recipes Progress
changed recipes: 298, 299 Finished

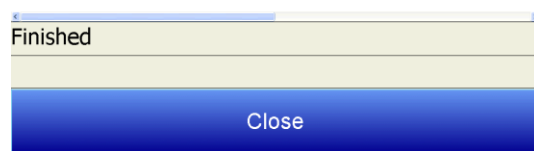

Show Backed Up Recipe

This feature allows the user to display a selected recipe from a selected backup. Using the navigation options outlined in the previous Backup/Restore sections, select a Backup and Recipe ID to display the details of that recipe:

Show Backed Up Recipe		Show Backed Up Recipe Progress			
Backup ID 1	ID: 5, Rev: 2.78, Date: 1/15/2018 2:28:15 PM	1 - SETPT	1399		wait
Recipe ID	299	2 - SETPT	1700	1.00 %C	wait
		3 - SOAK			0:01
		4 - EVT_OUT			3-On
		5 - SETPT	1600		wait
		6 - DELAY			5 sec
		7 - EVT_OUT			3-Off
		8 - SETPT	1600	0.80 %C	wait
		9 - SOAK			0:01
		10 - EVT_OUT			1-On
		11 - ALARM			User Alarm 1
		12 - EVT_OUT			1-Off

Edit

Start

Cancel

Close

Show Instrument Recipe

This feature allows the user to load a selected recipe from the instrument and display it. Using the navigation options outlined in the previous Backup/Restore sections, select a Backup and Recipe ID to display the details of that recipe:

Show Instrument Recipe Progress				
1 - SETPT	1300			wait
2 - SETPT	1700	1.00 %C		wait
3 - SOAK				0:01
4 - EVT_OUT				3-On
5 - SETPT	1600			wait
6 - DELAY				5 sec
7 - EVT_OUT				3-Off
8 - SETPT	1600	0.80 %C		wait
9 - SOAK				0:01
10 - EVT_OUT				1-On
11 - ALARM				User Alarm 1
12 - EVT_OUT				1-Off

Close

Restore Serial Communications

This feature writes the serial communications values for RS485 host, RS485 slave 1 and slave 2, RS232 host, PLC type and 9010 Modbus address from the selected backup to the 9010. The original touch screen interface communication settings are also restored from the backup to the screen. The screen must be wired and configured just as it was at the time the backup was made. The routine tries various ports and media to communicate. If communications can be established, the feature will restore the registers and settings to the instrument.

Using the navigation options outlined in the previous Backup/Restore sections, select a Backup and tap "Start" to restore communication setups:

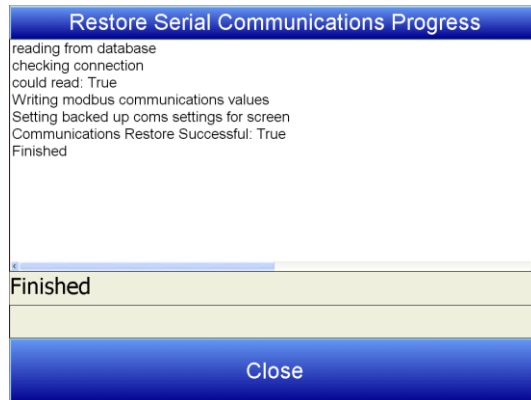
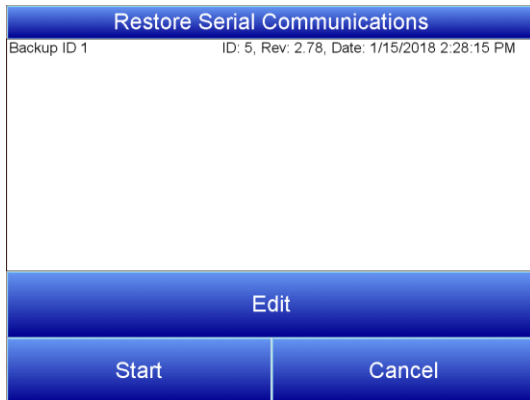

Check Current Communications

This feature displays the touch screen communication settings and whether the screen can communicate with the 9010.

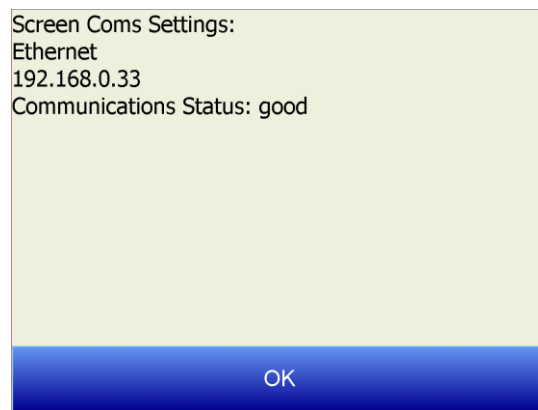

Read/Write Data

This menu option is protected by the SSi special passcode. Contact SSi at 513-772-0060 to obtain this passcode before making any changes.

This menu option allows unfiltered access to the internal registers and is used for troubleshooting only

Language

This menu option allows the user to select the display language of the touchscreen interface.

- | | |
|--|--|
| <input checked="" type="checkbox"/> ctrl TC | <input type="checkbox"/> Aux Input 13 |
| <input checked="" type="checkbox"/> Input 1 | <input type="checkbox"/> Aux Input 14 |
| <input checked="" type="checkbox"/> Input 2 | <input type="checkbox"/> Aux Input 15 |
| <input checked="" type="checkbox"/> Input 3 | <input type="checkbox"/> Aux Input 16 |
| <input checked="" type="checkbox"/> Aux Input 1 | <input type="checkbox"/> Aux Input 17 |
| <input checked="" type="checkbox"/> Aux Input 2 | <input type="checkbox"/> Aux Input 18 |
| <input checked="" type="checkbox"/> Aux Input 3 | <input type="checkbox"/> Aux Input 19 |
| <input checked="" type="checkbox"/> Aux Input 4 | <input type="checkbox"/> Aux Input 20 |
| <input checked="" type="checkbox"/> Aux Input 5 | <input type="checkbox"/> Aux Input 21 |
| <input checked="" type="checkbox"/> Aux Input 6 | <input type="checkbox"/> Aux Input 22 |
| <input type="checkbox"/> Aux Input 7 | <input type="checkbox"/> Aux Input 23 |
| <input type="checkbox"/> Aux Input 8 | <input type="checkbox"/> Aux Input 24 |
| <input type="checkbox"/> Aux Input 9 | <input type="checkbox"/> Aux Input 25 |
| <input checked="" type="checkbox"/> Aux Input 10 | <input checked="" type="checkbox"/> Aux Input 26 |
| <input checked="" type="checkbox"/> Aux Input 11 | <input checked="" type="checkbox"/> Aux Input 27 |
| <input checked="" type="checkbox"/> Aux Input 12 | <input checked="" type="checkbox"/> Aux Input 28 |

Load TC Map

Load TC Map allows the user to select which Load TCs will be available when using the LTC_SET opcode. Only those TCs selected on this screen will appear as an option when using the opcode. See the description of the LTC_SET opcode for more information.

Chart Settings

Chart Settings allows the user to set the default display behavior of the trend chart, specifically in regards to the cursor. See the Chart section for details on the display chart feature.

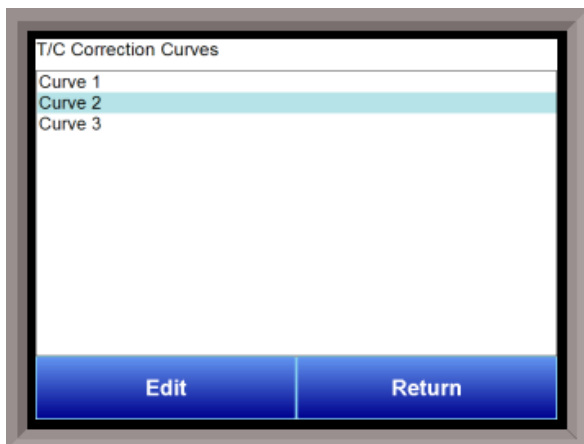
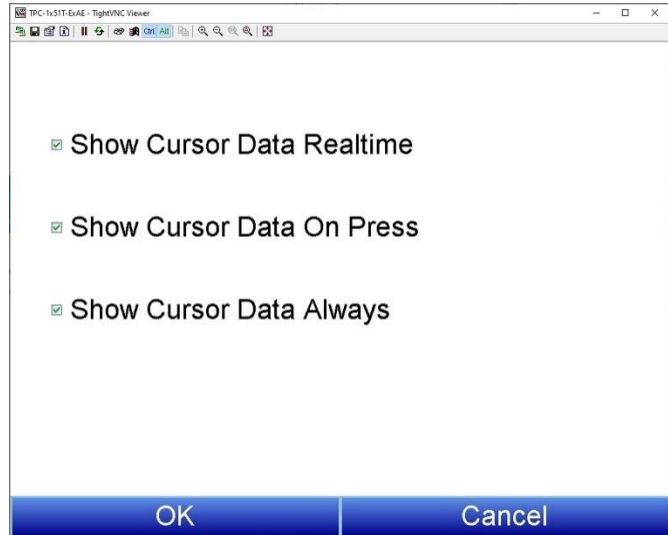

T/C Correction Curves

This menu option will allow the user to set up to three TC correction curves for the 9010 controller, as well as three auxiliary correction curves. Clicking on the desired curve will display the curve edit form. *Note: If the first "Temp" value and the first "Error" value are both zero, then the curve will not be set.* The user can enter up to ten "Temp"/"Error" combinations. The range for the "Temperature" field is **-32768 to 32767**.

The range for the "Error" field is **-32768.000 to**

32767.000.

Generic Instruments

The initial *Generic Instruments* screen has the choice *Generic Instrument Editor*. The *Generic Instrument Editor* is available to customize slave Modbus instruments that are not explicitly supported by the 9010. To modify generic instrument setups, select this option and press the **Edit** key.

This will display a list of instrument choices from 1-16.

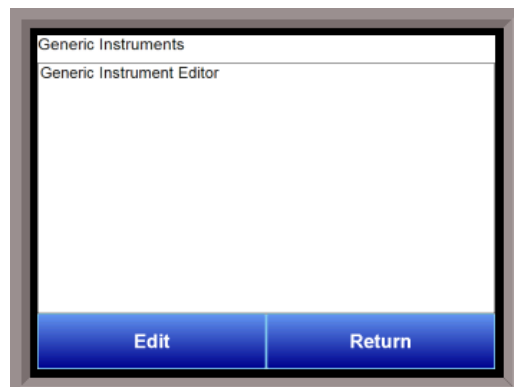

The generic instrument's data will be stored in certain registers on the host instrument, such as the 9010 controller. Each instrument is allotted a certain set of registers, starting with register 1000. To determine the beginning register, use the following calculation: $(100 * \text{generic instrument's number (1 - 16)}) + 900$. Therefore, instrument 1 would begin at register 1000: $(100 * 1) + 900$. Instrument 7 would begin at register 1600: $(100 * 7) + 900$. Each instrument is allotted 100 registers, therefore, instrument 1's allotment is from register 1000 to 1099 on the 9010 controller, instrument 2's allotment is from register 1100 to 1199 on the 9010 controller, etc.

The *Generic Instrument Editor* menu is split into two parts: **Coms**, and **Data**. The screen lists the generic instruments from Instrument 1 to Instrument 16. Select the desired instrument to configure, then choose **Coms** or **Data**.

Coms

The three reads can be set up on this screen.

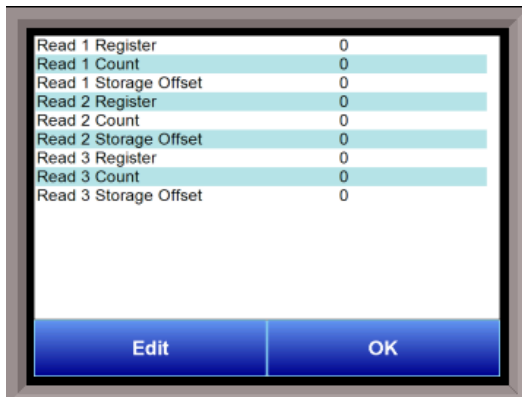

Read 1 Register, Read 2 Register, Read 3 Register

The Read *X* Register field will be the register in the 9010 controller that the instrument will read from. The range is **0 – 327678**.

Read 1 Count, Read 2 Count, Read 3 Count

The Read *X* Count field will be the number of successive registers to read. The range is **0 – 100**.

Read 1 Storage Offset, Read 2 Storage Offset, Read 3 Storage Offset

The Read *X* Storage Offset field will be the offset in the generic instruments registers (1000 – 1099 for Instrument 1, 1100 to 1199 for Instrument 2, etc). The range is **0 – 100**.

Data

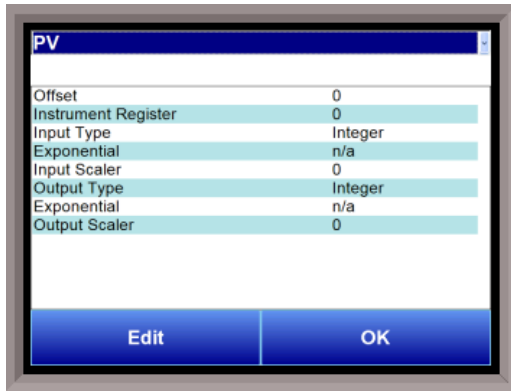

The button at the top of the **Data** screen can be changed to modify either the process variable (**PV**), set point (**SP**), or the output (**Out**) for each generic instrument. For these three choices, the user can adjust the offset, instrument register, the input type and its exponential status and scaler value, and the output type and its exponential status and scaler value.

Aux Input Offset Correction

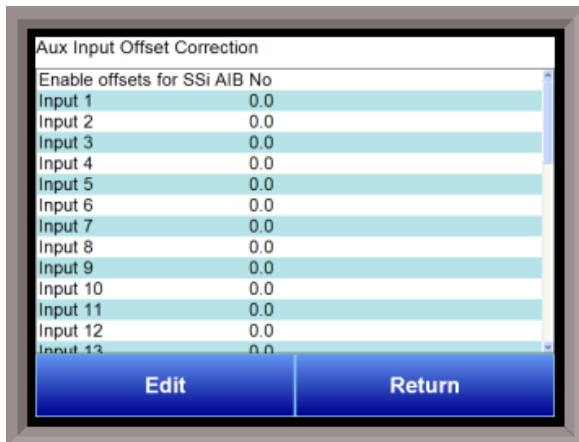

This option can be used to adjust the entire scale of a particular input. To add an offset, first select the **Enable offsets for SSi AIB** button, and select **Yes**. Then select the input that needs to be changed and press the **Edit** button. This will display a number pad and allow an offset to be added to the input. To save the offset, press **OK**. To return to the *Aux Input Offset Correction* screen without saving changes, press **Esc**.

Chapter 4 - Series 9010 “Opcodes”

Programmer Description

The Series 9010 Series Atmosphere/Temperature Recipe Programmer provides a convenient operator interface and recipe programmer.

The programmer uses enhanced opcodes that reduce the number of steps required for a program. Each step consists of an opcode, a temperature value, an atmosphere value, and an option value. The opcode determines how and if each of the three values is used.

An explanation of wait, wait up, and wait down options can be found at the end of this chapter.

Opcodes

NO-OP This no operation code does nothing and is used as a place hold on programs that are less than 12 steps.

ALARM This alarm function is used to notify the operator that an operation is complete or that a manual action is required. The program waits until the alarm is acknowledged to proceed.

ATM_INQ The atmosphere inquiry is used to wait for the actual atmosphere to reach the set point.

The options are:

- wait: the PV must be within the wait limit band specified to continue the recipe
- wait up: the PV must be at or above the set point to continue the recipe
- wait down: the PV must be at or below the set point to continue the recipe.

An explanation of wait, wait up, and wait down options can be found at the end of this chapter.

The default band can be set under the Configuration Menu and is typically 10 (i.e. 0.10 percent carbon).

- The *SET_WAIT* opcode will change the band limit
- The *LIMIT* opcode immediately following this opcode sets a time limit on the wait.
- A *BRANCH* opcode immediately following this opcode can be used to change the program flow based on the inquiry results.

BRANCH This opcode can change program flow based upon an inquiry opcode. The temperature data is interpreted as a program step if the inquiry is true and the atmosphere data as a program step if the inquiry is false.

BO_START This opcode will allow the start of a burnoff from the controller.

The options are:

- Start
- Start + Wait
- Check + Wait

Choosing an option with a Wait ensures that the PV must be within the wait limit specified to continue the recipe. An explanation of wait, wait up, and wait down options can be found at the end of this chapter.

CC_SP_L The *Cascade Setpoint Limit* opcode will allow the user to set the upper and lower limits for the cascade setpoint. The temperature data is the lower limit, and the atmosphere data is the upper limit.

DELAY This opcode is used when a short delay is needed. The option value is the delay time in seconds.

DEV_AL This deviation alarm opcode is used to turn the temperature or atmosphere deviation alarms ON or OFF.

The option values are:

- OFF, turns off both the temperature and atmosphere alarms;
- TEMPERATURE, turns on the temperature alarm and turns off the atmosphere alarm;
- ATMOSPHERE, turns on the atmosphere alarm and turns off the temperature alarm; and
- BOTH, turns on both the temperature and the atmosphere alarms.
- The band limit can be changed by the *SET_WAIT* opcode.

DOW_INQ This opcode checks the real time clock for the day of the week. This is useful for performing operations on a weekly basis on a specific day. The option data is the day of the week, i.e. SUN, MON, TUE, WED, THU, FRI, and SAT.

EVT_IN This opcode waits for an input event to be turned ON or OFF depending on the option value. The option value is the event number followed by either ON or OFF.

If temperature data and or atmosphere data are specified, they are considered set points and will be sent to the appropriate controller.

EVT_OUT The *Event Output* opcode turns ON or OFF an output event based upon the option value. . The option value is the event number followed by either ON or OFF.

If temperature data and or atmosphere data are specified, they are considered set points and will be sent to the appropriate controller.

G_Ramp This is a guaranteed ramp opcode. The temperature and or atmosphere process value must be within the wait limit band to allow the ramp timer to run. The option values are the ramp time in hours and minutes, temperature and/or atmosphere set point. The band limit can be changed by the *SET_WAIT* opcode.

G_SOAK This is a guaranteed soak opcode. The temperature process value must be within the wait limit band to allow the soak timer to run. The option value is the soak time in hours and minutes. The band limit can be changed by the *SET_WAIT* opcode.

GHSOAK This is a guaranteed soak high opcode. Anything below the high limit will satisfy the guarantee and allow the soak timer to run. The option value is the soak time in hours and minutes. The band limit can be changed by the *SET_WAIT* opcode.

GLSOAK This is a guaranteed soak low opcode. Anything above the lower limit will satisfy the guarantee and allow the soak timer to run. The option value is the soak time in hours and minutes. The band limit can be changed by the *SET_WAIT* opcode.

GDELAY This opcode is a guaranteed short delay, ensuring that the thermocouples are within the deviation band. It guarantees on the temperature loop unless the load TCs are enabled, in which case it guarantees against the load TC map for the specified number of seconds.

GHDELAY This opcode is a guaranteed high short delay opcode. Anything below the high limit will satisfy the guarantee and allow the soak timer to run.

GHZDELAY This opcode is a guaranteed zone high short delay. Anything below the high limit will satisfy the guarantee and allow the soak timer to run. It is similar to the GDELAY opcode except that zone instruments (if available) are included. If load TCs are enabled, the control TC must be enabled to include the zone instruments. If the Control TC is disabled, the zone instruments will not be evaluated.

GHZSOAK This is a *Guaranteed Soak High* opcode for a zone. Anything below the high limit will satisfy the guarantee and allow the soak timer to run. The option value is the soak time in hours and minutes. The band limit can be changed by the *SET_WAIT* opcode.

GLDELAY This opcode is a guaranteed low short delay opcode. Anything above the lower limit will satisfy the guarantee and allow the soak timer to run.

GLZDELAY This opcode is a guaranteed zone low short delay. Anything above the lower limit will satisfy the guarantee and allow the soak timer to run. It is similar to the GDELAY opcode except that zone instruments (if available) are included. If load TCs are enabled, the control TC must be enabled to include the zone instruments. If the Control TC is disabled, the zone instruments will not be evaluated.

GLZSOAK This opcode is a guaranteed zone low short soak. Anything above the lower limit will satisfy the guarantee and allow the soak timer to run. It is similar to the GSOAK opcode except that zone instruments (if available) are included. If load TCs are enabled, the control TC must be enabled to include the zone instruments. If the Control TC is disabled, the zone instruments will not be evaluated.

GOSUB The go to subroutine opcode is used to call a program and then return to the calling program. This is used to execute standard routines that can be used by many programs. *GOSUBs* can be stacked up to eight levels. The option data is the program number.

GTCINQDEL This is a guaranteed TC inquiry short delay opcode. It is used to verify that all active thermocouples are within the set wait limits around the setpoint for the user defined time period. The temperature data is the delay time in seconds. The vacuum data is the control TC or the load tc's. The options are:

- wait: the PV must be within the wait limit band specified to continue the recipe
- wait up: the PV must be at or above the set point to continue the recipe
- wait down: the PV must be at or below the set point to continue the recipe.

An explanation of wait, wait up, and wait down options can be found at the end of this chapter.

GZDELAY This opcode is a guaranteed short zone delay. It is similar to the GDELAY opcode except that zone instruments (if available) are included. If load TCs are enabled, the control TC must be enabled to include the zone instruments. If the Control TC is disabled, the zone instruments will not be evaluated.

GZRAMPT This is a *Guaranteed Ramp* opcode for a zone. The process value must be within the wait limit band to allow the ramp timer to run. The temperature data is the temperature set point, the atmosphere data is the atmosphere setpoint, and the option data is the ramp time in hours and minutes. The band limit can be changed by the *SET_WAIT* opcode.

GZ_SOAK This is a *Guaranteed Soak* opcode for a zone. The temperature process value must be within the wait limit band to allow the soak timer to run. The option value is the soak time in hours and minutes. The band limit can be changed by the *SET_WAIT* opcode.

HIGH_AL This opcode is used to enable a high limit alarm on the temperature process and/or the atmosphere process. The temperature data is the high limit point for the temperature process. The atmosphere data is the high limit point for the atmosphere process. This alarm remains active until the program ends.

HIGH_PO This opcode is used to enable a high limit alarm on the temperature percent output and/or the atmosphere percent output. The temperature data is the high limit point for the temperature percent output. The atmosphere data is the high limit point for the atmosphere percent output. This alarm remains active until the program ends.

ID_SET This opcode is used to set the ID number to the value specified in the temperature data. The atmosphere and option data are not used. The ID number is provided as a feature to track loads or jobs and is not used by any controller.

ID_INC This opcode increments the ID number by one. No data is required.

ID_INQ This opcode is used to compare the ID value to the value in the temperature data. The option data is equal, high, or low. The *LIMIT* opcode immediately following this opcode sets a time limit on the wait. A *BRANCH* opcode immediately following this opcode can be used to change the program flow based on the inquiry results.

IN_inq The *Input Inquiry* opcode will allow the user to check one of the inputs for a specific value. The temperature data is the value to check for. The atmosphere data is the input to check. The options are:

- wait: the PV must be within the wait limit band specified to continue the recipe
- wait up: the PV must be at or above the set point to continue the recipe
- wait down: the PV must be at or below the set point to continue the recipe.

An explanation of wait, wait up, and wait down options can be found at the end of this chapter.

The *LIMIT* opcode immediately following this opcode sets a time limit on the wait. A *BRANCH* opcode immediately following this opcode can be used to change the program flow based on the inquiry results.

JUMP The *JUMP* opcode is used to goto another program when no return is needed. The option data is the program number to execute next.

LIMIT This option is used to place a time limit on a wait or inquiry step. The option data is the time limit to wait in hours and minutes. Should the time run out before the wait or inquiry is satisfied an alarm occurs.

LOW_AL This opcode is used to enable a low limit alarm on the temperature process and/or the atmosphere process. The temperature data is the low limit point for the temperature process. The atmosphere data is the low limit point for the atmosphere process. This alarm remains active until the program ends.

LOW_PO This opcode is used to enable a low limit alarm on the temperature percent output and/or the atmosphere percent output. The temperature data is the low limit point for the temperature percent output. The atmosphere data is the low limit point for the atmosphere percent output. This alarm remains active until the program ends.

LTC_SET

This opcode sets the active load T/C map for the furnace. Checking the box next to the T/C number selects the T/C. The options are off, on, or on + alarms.

This Opcode is the same as Zone/Load TC Setup via the Menu options (see sections on Zone/Load TC Setup) except that it selects thermocouples from the recipe. This may be helpful when certain recipes require three Load TCs and other require six Load TCs.

NOTE: Only TCs selected in the Load TC Map will be available here. See the Configuration section for more details.

MV_INQ The millivolt inquiry is used to wait for the probe millivolts to reach the value specified in the atmosphere data.

The options are:

- wait: the PV must be within the wait limit band specified to continue the recipe
- wait up: the PV must be at or above the set point to continue the recipe
- wait down: the PV must be at or below the set point to continue the recipe.

An explanation of wait, wait up, and wait down options can be found at the end of this chapter.

The *LIMIT* opcode immediately following this opcode sets a time limit on the wait.

A *BRANCH* opcode immediately following this opcode can be used to change the program flow based on the inquiry results.

PIDLOAD This opcode will load an alternate PID set from the controller memory. The temperature data is the Loop 2 PID, the atmosphere data is the Loop 1 PID, and the option data is the Loop 3 PID. A value of **-1** will disable each Loop PID. **1 – 16** will load the corresponding alternate PID group.

PLC_SET_VAL This opcode will set specially configured values in a slave PLC. Registers to be written to must be described via the Configurator's Recipe Management Group Opcode Control interface. The temperature data is the value to write. The atmosphere data is the Write location. This can be:

Quench SP
Endo SP
Ammonia SP
N2 SP
Methanol SP
Quench Sec
Drain Sec
T.C. Endo SP
T.C. N2 SP
FNC NH3 SP
T.C. Time
PLC Quench SP
Quench Type

The options are:

- wait: the PV must be within the wait limit specified to continue the recipe
- wait up: the PV must be above the lower wait limit to continue the recipe
- wait down: the PV must be at or below the upper wait limit to continue the recipe.
- Or nothing

PO_INQ The percent output inquiry is used to test the actual percent output of the temperature and/or atmosphere controller.

The options are:

- wait: the PV must be within the wait limit band specified to continue the recipe
- wait up: the PV must be at or above the set point to continue the recipe
- wait down: the PV must be at or below the set point to continue the recipe.

An explanation of wait, wait up, and wait down options can be found at the end of this chapter.

The *LIMIT* opcode immediately following this opcode sets a time limit on the wait.

A *BRANCH* opcode immediately following this opcode can be used to change the program flow based on the inquiry results.

QTCSET This is the *Quench Instrument Setpoint* opcode. This will allow the user to set the setpoint for a quench cycle. The temperature data is the temperature setpoint.

QUENCH The *QUENCH* opcode is used to start a quench cycle. The quench cycle is independent of any program that is running. The temperature data is the quench temperature controller set point. The atmosphere data is the quench time in minutes. The option data can be used to control the agitator speed, high or low, by Event # 6. Event # 6 OFF equals low speed, and Event # 6 ON equals high speed. The quench temperature controller must be *Aux Instrument # 4*. The quench cycle starts when the opcode is executed. The set point is sent to the quench temperature controller, the timer is started, and the high-speed event is turned on if it is selected. When the quench timer times out, the end of quench cycle (Event # 7) is turned on for one minute and the high speed event is turned off.

RAMP This opcode changes the temperature set point and/or the atmosphere set point linearly over time. The option data is the total ramp time in minutes. The temperature data specifies the final set point for the temperature set point. The atmosphere data specifies the final value for the atmosphere set point.

RAMPR This opcode changes the temperature set point at a rate of degrees per minute. The option data is the final temperature set point and rate of degrees per minute.

RUN_SLAVE This opcode will change the temperature set point of an auxiliary instrument at a rate of degrees per minute. The temperature data provides the final setpoint. The atmosphere data is the auxiliary instrument to change the setpoint on (1 – 12). The option data is the rate change in degrees per minute.

RESET This opcode is used to clear all stacks and timers and start a program. The temperature data is interpreted as a program number and the atmosphere data as a program step. The option data is not used. The *RESET* is useful in a weekend shut down program to restart the normal operating program.

SET_AUX The *Set Auxiliary Instrument Setpoint* opcode is used with other instruments in the process such as flow control or belt speed. The temperature data is the set point and the option data is the instrument number.

SET_BP This opcode is used to set the backpressure set point. The atmosphere data is the atmosphere setpoint. The options are:

- wait: the PV must be within the wait limit band specified to continue the recipe

- wait up: the PV must be at or above the set point to continue the recipe
- wait down: the PV must be at or below the set point to continue the recipe.

An explanation of wait, wait up, and wait down options can be found at the end of this chapter.

SET_FACT This opcode is used to set the CO factor or the H2 factor of the atmosphere controller. If the atmosphere type for the loop is set to dew point then the H2 factor is set; otherwise the CO factor is set. The temperature data is not used. The atmosphere data is used as the factor with decimal places ignored. The options are:

- wait: the PV must be within the wait limit band specified to continue the recipe
- wait up: the PV must be at or above the set point to continue the recipe
- wait down: the PV must be at or below the set point to continue the recipe.

An explanation of wait, wait up, and wait down options can be found at the end of this chapter.

This allows the control loop to recover from the change before continuing the program.

SET_FCM This opcode sets the gas flow control mode. There are four options: Individual trim, Flow control adjusts two valves, Ratio control – Maintains constant ratio between NH3 +, Auto switch – Switches between Options 1 & 2 based on the DA switch point.

- **Individual Trim will adjust the Gas flow of a valve if Trim is enabled.**
- **Flow Control adjusts the flows of all enabled valves by the same percentage.**
- **Ratio Control maintains a constant total flow of gas into the furnace by adjusting only the Ammonia and Dissociated Ammonia flows. This does not apply to the Nitrogen or Aux Valves.**

SET_LP3 This opcode will set the Loop 3 setpoint, if applicable. The temperature data is the setpoint. Set Loop 3 functionality is similar to the SET_BP opcode, except that there is no decimal place applied on Set Loop 3.

SET_SL_VAL This opcode will set the setpoint on an auxiliary slave controller. The temperature data is the setpoint. The atmosphere data is the register to set. The option data is the instrument number.

SET_VALVE This opcode will set one of four valves. The temperature data is the setpoint. The atmosphere data is the trim range. Setting the trim range to any positive number will enable the trim for the selected valve. Setting the trim range to a 0 will disable the trim for the selected valve. *Note: leaving the trim disabled will make no changes to the current trim configuration.* The option data is the valve selection. The valve can be: **Nitrogen, Ammonia, Disassociated Ammonia, or Endo.**

SET_WAIT This opcode sets the band limits for the wait option or *Inquiry* opcodes. The temperature data specifies the temperature band (i.e. +/- the value) and the atmosphere data specifies the atmosphere band.

SETPT This opcode is used to set the temperature and/or atmosphere set points. Either or both of the set points can be specified. The options are:

- wait: the PV must be within the wait limit band specified to continue the recipe
- wait up: the PV must be at or above the set point to continue the recipe
- wait down: the PV must be at or below the set point to continue the recipe.

An explanation of wait, wait up, and wait down options can be found at the end of this chapter.

If both set points are specified the Wait applies to both.

SL_PV_INQ The slave process variable inquiry is used to determine whether or not the auxiliary instrument has reached the target input for its specific process variable.

SOAK This opcode is an unconditional soak for the time (in hours and minutes) specified in the option data.

TC_CHK This opcode enables or disables the comparison of two or three TCs to be sure that they are tracking and operating correctly. The TC Check setups are configured in the Alarm setups for the programmer. The temperature data is the first TC Source. The atmosphere data is the second TC source. The option data is the third TC source.

TC_INQ The temperature inquiry is used to wait for the actual control temperature to reach the set point.

The options are:

- wait: the PV must be within the wait limit band specified to continue the recipe
- wait up: the PV must be at or above the set point to continue the recipe
- wait down: the PV must be at or below the set point to continue the recipe.

An explanation of wait, wait up, and wait down options can be found at the end of this chapter.

The default band can be set under the Configuration Menu and is typically 15 degrees. The band limit can be changed by the *SET_WAIT* opcode. The *LIMIT* opcode immediately following this opcode sets a time limit on the wait. A *BRANCH* opcode immediately following this opcode can be used to change the program flow based on the inquiry results.

TimeEvt This opcode will turn an output event on or off for the specified delay time, in seconds. The timeEvt opcode differs further from the standard event opcode in that you may not set any loop setpoints. The atmosphere data is the delay time. The option is the event on or off.

TOD_INQ This opcode is a time of day inquiry that would be used to start a process or subroutine at a specific hour and minute. The option data is the time in 24-hour format (i.e. 2:30pm is 14:30).

TZ_INQ The zone temperature inquiry is used to wait for the actual control zone temperature to reach the value specified in the Temperature data.

The options are:

- wait: the PV must be within the wait limit band specified to continue the recipe
- wait up: the PV must be at or above the set point to continue the recipe
- wait down: the PV must be at or below the set point to continue the recipe.

An explanation of wait, wait up, and wait down options can be found at the end of this chapter.

The default band can be set under the *Configuration* Menu and is typically 15 degrees. The band limit can be changed by the *SET_WAIT* opcode.

The *LIMIT* opcode immediately following this opcode sets a time limit on the wait. A *BRANCH* opcode immediately following this opcode can be used to change the program flow based on the inquiry results.

Z_SETPT This opcode is used to set the temperature and/or vacuum set points for a zone. Either or both

of the set points can be specified.
The options are:

- wait: the PV must be within the wait limit band specified to continue the recipe
- wait up: the PV must be at or above the set point to continue the recipe
- wait down: the PV must be at or below the set point to continue the recipe.

An explanation of wait, wait up, and wait down options can be found at the end of this chapter.

If both set points are specified, the Wait applies to both.

ZONE_OFF The *Zone Offset* opcode is used to set an offset to be added to the set point sent to a specific zone. Temperature, atmosphere, or both can be offset. The same loop (furnace) can have different offsets for each zone. The zones must be defined in the zone configuration.

For example, a pit furnace has three zones: top, middle, and bottom.

The zones could be defined as:

- top = zone 1,
- middle = zone 2 ,
- bottom = zone 3.

If the *ZONE_OFF* opcode is used in a program with temperature data = 50 and zone = 1, then a temperature set point value in the following steps of 1700 would be sent to the middle and bottom as 1700 and the top as 1750.

Wait

When using the option **wait** with a set point Opcode, the recipe will not advance to the next step until the PV value falls within the **wait limit band**. The wait limit band is defined as Set Point plus/minus the **active tolerance**. The active tolerance begins each recipe as the value defined as the **default wait limit**; this can be changed using the **SET_WAIT** opcode.

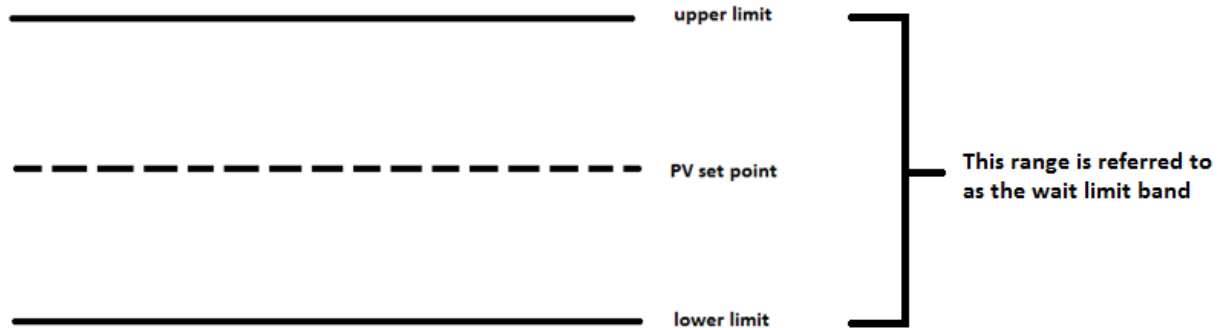

For example, assume a Set Point of 1500° and a wait limit of 15°. Using the **SETPT** opcode paired with a **wait** option, the recipe will not advance until the temperature PV is between 1485°-1515°.

Wait Up

When using the option **wait up** with a set point opcode, the recipe will not advance to the next step until the PV value reaches or exceeds the set point. The recipe will then continue to the next step.

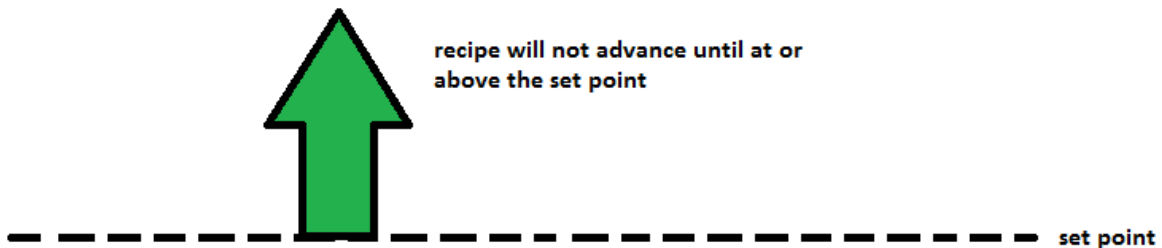

Opcode assigned to wait up

For example, if the PV is temperature with a set point of 1500° and the wait limit is 15°, the recipe will not advance until the PV is at or above 1500°.

Wait Down

When using the option **wait down** with a set point opcode, the recipe will not advance to the next step until the PV value reaches or falls below the set point. The recipe will then continue to the next step.

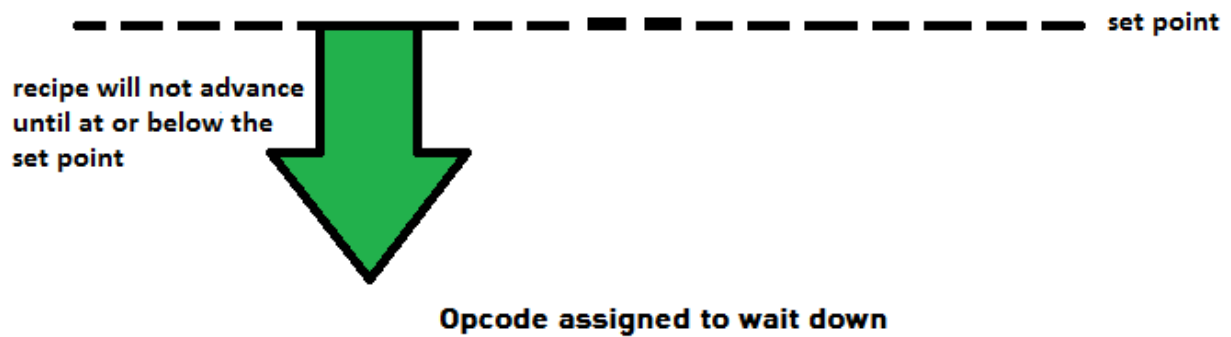

For example, if the PV is temperature with a 1500° set point and the wait limit is 15°, the recipe will not advance until the PV is at or below 1500°.

Wait in a Guaranteed Soak

During a **guaranteed soak** in a recipe the timer will continue to count down while the PV value is within the **wait limit band**. If the value of the PV moves outside of this range, the timer will pause until the PV value falls back within the **wait limit band**.

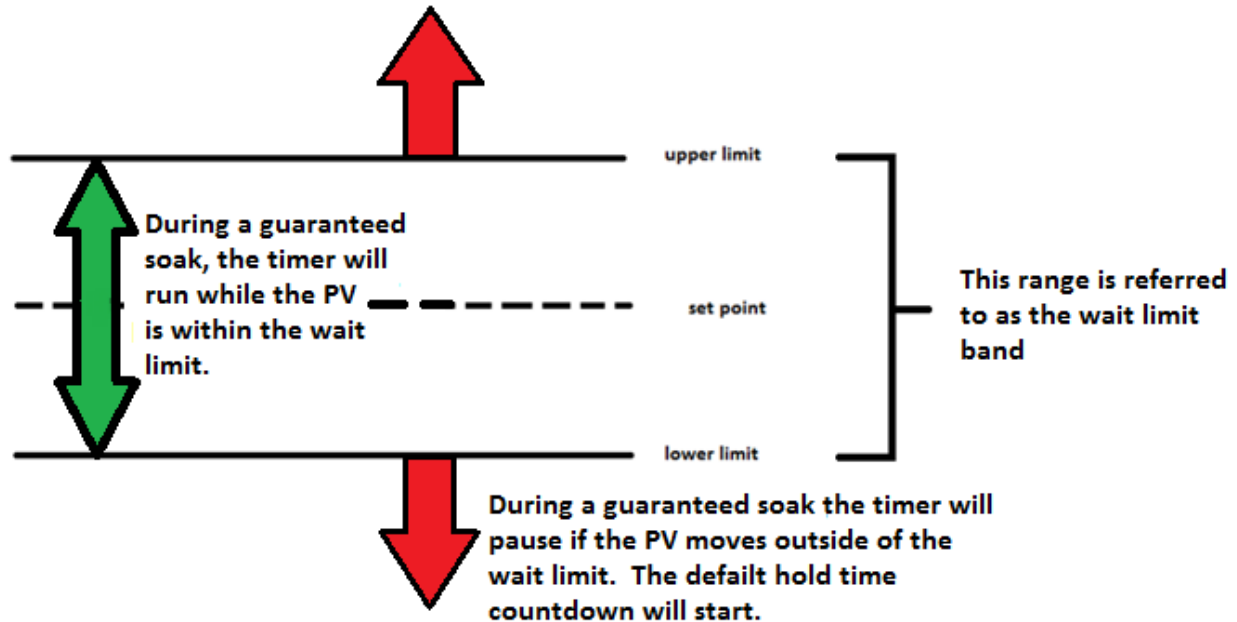

If the PV value moves outside of the **wait limit band**, the recipe will pause and a new timer will begin. This timer is called the **Default Hold Time** and can be found and adjusted in the **Menu** under **Furnace Setup**. This timer will keep track of the amount of time the PV value has been outside of the **wait limit**. If the PV value fails to move back into the **wait limit band** within the **Default Hold Time**, the programmer alarm will be activated. Once the PV value moves back within the **wait limit band**, the soak timer will resume.

For example, if the PV is temperature with a set point of 1500° and the wait limit is 15°, the recipe timer will run only while the temperature is 1485°-1515°. If the PV moves outside of this range, the recipe timer will pause and the Default Hold Time countdown will begin. The recipe timer will resume once the PV moves back into the range of 1485°-1515°.

Guarantee High Assignment

An opcode with a **GH** prefix stands for **guarantee high**. During a recipe, a **guarantee high** will allow the recipe timer to run only while the PV is at or below the **upper limit**. The **upper limit** is the value of the **set point** plus the **wait limit**.

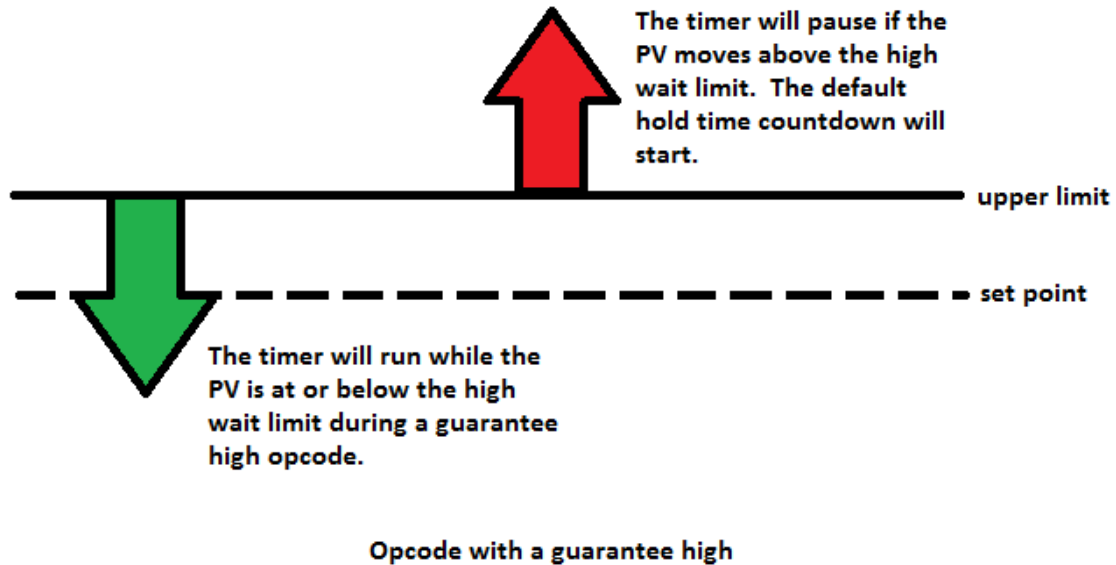

If the PV moves above the **upper limit**, the recipe will pause and a new timer will begin. This timer is called the **Default Hold Time** and can be found and adjusted in the **Menu** under **Furnace Setup**. This timer will keep track of the amount of time the PV has been above the **upper limit**. If the PV fails to move below the **upper limit** within the **Default Hold Time**, the programmer alarm will be activated. Once the PV moves below the **upper limit**, the recipe timer will resume.

For example, if the PV is temperature with a 1500° set point and the wait limit is 15°, the recipe timer will continue to run as long as the PV is at or below 1515°. If the PV moves above 1515°, the recipe timer will pause and the Default Hold Time countdown will begin. The recipe timer will resume once the PV moves back to 1515° or below.

Guarantee Low Assignment

An opcode with a **GL** prefix stands for **guarantee low**. During a recipe, a **guarantee low** will allow the recipe timer to run only while the PV is at or above the **lower limit**. The **lower limit** is the value of the **set point** minus the **wait limit**.

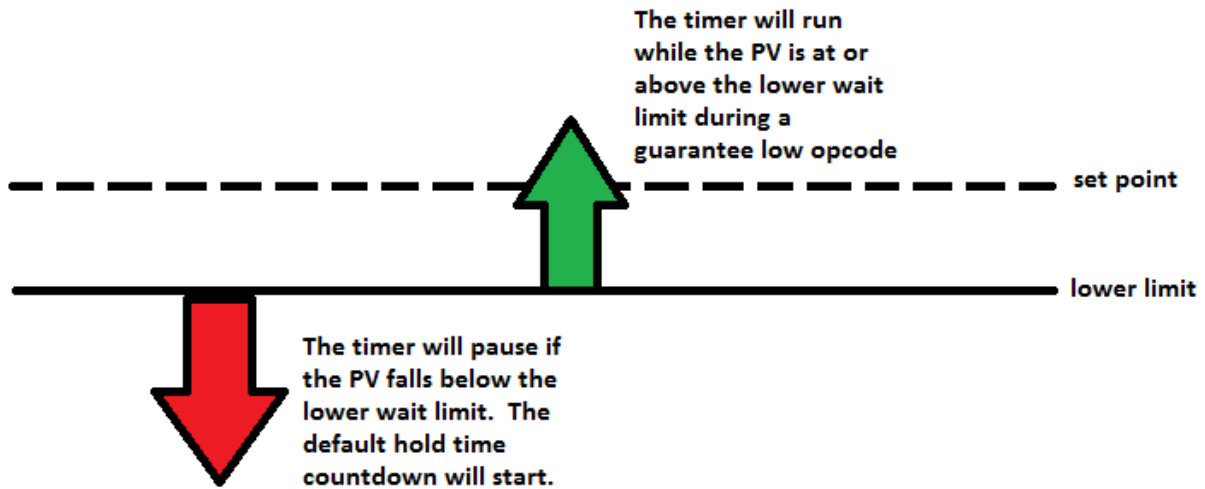

Opcode with a guarantee low

If the PV moves below the **lower limit**, the recipe will pause and a new timer will begin. This timer is called the **Default Hold Time** and can be found and adjusted in the **Menu** under **Furnace Setup**. This timer will keep track of the amount of time the PV has been below the **lower limit**. If the PV fails to move above the **lower limit** within the **Default Hold Time**, the programmer alarm will be activated. Once the PV moves above the **lower limit**, the recipe timer will resume.

For example, if the PV is temperature with a 1500° set point and the wait limit is 15°, the recipe timer will continue to run as long as the PV is at or above 1485°. If the PV moves below 1485°, the recipe timer will pause and the Default Hold Time countdown will begin. The recipe timer will resume once the PV moves back to 1485° or above.

Chapter 5 - APPLICATIONS INFORMATION

Standard Event Assignments

To simplify operation and maintain consistency, SSI has adopted the following event assignments.

Event 0	Relay output 1
Event 1	Relay output 2
Event 2	Relay output 3
Event 3	Relay output 4
Event 4	Relay output 5
Event 5	Relay output 6
Event 6	Relay output 7
Alarm	Relay output 8

Note: AC20 event outputs are labeled 10 through 17 for outputs 0 through 7.

Appendix A – Slave Instrument Mapping

The following tables can be used as a reference for retrieving information such as the PV, setpoint, etc from a slave instrument. The slave instrument information will have a base offset based on the instrument number that is assigned. The base offset can be determined using the following formula:

$$\text{Base Offset} = (\text{Instrument Number} * 100) + 900$$

For example, the base offset for instrument 1 would be 1000 \rightarrow (1 * 100) + 900, and the base offset for instrument 7 would be 1600 \rightarrow (7 * 100) + 900. The slave instruments will be split into three sections: Atmosphere Instruments, Temperature Instruments, and Events Instruments. The layout for each instrument will be the same:

- Controller – The type of controller the slave instrument is – i.e. AC20, Series 9010, etc.
- Source Location – The register *in the controller* where the specified value is located. *Note: These will be added on to the base offset of the instrument (see above section).* For example, the source location for %C actual for an AC20 is 11. For instrument 1, the register to find the %C actual would be 1011 \rightarrow the base offset for instrument 1 is 1000, plus the source location of 11.
- Write Register – The register *within the slave instrument* where the value will be written.
- Read Scale – Any value read in from an instrument will be divided by this number for display purposes only.
- Write Scale – Any value written to an instrument will be multiplied by this number for display purposes only.
- Description – This will be a brief description of what the value is, i.e. %C actual, Setpoint, etc.

The following tables can be used as a reference for retrieving information such as the PV, setpoint, etc from a slave instrument. The slave instrument information will have a base offset based on the instrument number that is assigned. The base offset can be determined using the following formula:

$$\text{Base Offset} = (\text{Instrument Number} * 100) + 900$$

For example, the base offset for instrument 1 would be 1000 \square (1 * 100) + 900 – and the base offset for instrument 7 would be 1600 \square (7 * 100) +900. The slave instruments will be split into three sections: Atmosphere Instruments, Temperature Instruments, and Events Instruments. The layout for each instrument will be the same:

- Controller – The type of controller the slave instrument is – i.e. AC20, Series 9010, etc.
- Source Location – The register *in the controller* where the specified value is located. *Note: These will be added on to the base offset of the instrument (see above section).* For example, the source location for %C actual for an AC20 is 11. For instrument 1, the register to find the %C actual would be 1011 \square the base offset for instrument 1 is 1000, plus the source location of 11.
- Write Register – The register *within the slave instrument* where the value will be written.
- Read Scale – Any value read in from an instrument will be divided by this number for display purposes only.
- Write Scale – Any value written to an instrument will be multiplied by this number for display purposes only.
- Description – This will be a brief description of what the value is, i.e. %C actual, Setpoint, etc.

Atmosphere Instruments

Controller	Source Location	Write Register	Read Scale	Write Scale	Description
AC20	11	123	1	1	%C Actual
(Modbus Mode)	29	138	1	1	%C Setpoint
	13	125	1	1	Probe Temperature
	10	122	1	1	Probe Millivolts
	20	130	10	10	%C Percent Output
	34	142	1	1	CO Factor or Equivalent
	35	143	1	1	H Factor or Equivalent
	12	124	1	1	Dew Point
	36	144	10	10	O2

Controller	Source Location	Write Register	Read Scale	Write Scale	Description
Yokogawa 750	2	2	1	1	%C Actual
(Modbus Mode)	3	100	1	1	%C Setpoint
	20	19	1	1	Probe Temperature
	10	122	1	1	Probe Millivolts
	4	4	10	10	%C Percent Output
	0	0	1	1	CO Factor or Equivalent
	0	0	1	1	H Factor or Equivalent

Controller	Source Location	Write Register	Read Scale	Write Scale	Description
UDC 3300's	1	0	1	1	%C Actual
(Modbus Mode)	3	2	1	1	%C Setpoint
	6	5	10	10	Probe Temperature
	5	4	10	10	Probe Millivolts
	4	3	10	10	%C Percent Output
	43	39	10	10	CO Factor or Equivalent
	43	39	10	10	H Factor or Equivalent

Controller	Source Location	Write Register	Read Scale	Write Scale	Description
Dualpro Loop 1	21	20	1	1	%C Actual
(Modbus Mode)	7	6	1	1	%C Setpoint
	18	17	8	8	Probe Temperature
	19	18	8	8	Probe Millivolts
	41	40	41	41	%C Percent Output
	4	3	1	1	CO Factor or Equivalent
	5	4	1	1	H Factor or Equivalent

Controller	Source Location	Write Register	Read Scale	Write Scale	Description
Dualpro Loop 2	21	20	1	1	%C Actual
(Modbus Mode)	8	7	1	1	%C Setpoint
	18	17	8	8	Probe Temperature
	19	18	8	8	Probe Millivolts
	42	41	41	41	%C Percent Output
	4	3	1	1	CO Factor or Equivalent
	5	4	1	1	H Factor or Equivalent

Controller	Source Location	Write Register	Read Scale	Write Scale	Description
Dualpro Loop 1	20	20	1	1	%C Actual
(MMI Mode)	6	6	1	1	%C Setpoint
	17	17	8	8	Probe Temperature
	18	18	8	8	Probe Millivolts
	40	40	41	41	%C Percent Output
	3	3	1	1	CO Factor or Equivalent
	4	4	1	1	H Factor or Equivalent

Controller	Source Location	Write Register	Read Scale	Write Scale	Description
Dualpro Loop 2	20	20	1	1	%C Actual
(MMI Mode)	7	7	1	1	%C Setpoint
	17	17	8	8	Probe Temperature
	18	18	8	8	Probe Millivolts
	41	41	41	41	%C Percent Output
	3	3	1	1	CO Factor or Equivalent
	4	4	1	1	H Factor or Equivalent

Controller	Source Location	Write Register	Read Scale	Write Scale	Description
Eurotherm 2404	1	1	1	1	%C Actual
(Modbus Mode)	5	5	1	1	%C Setpoint
	72	11073	1	1	Probe Temperature
	61	11062	1	1	Probe Millivolts
	4	4	1	1	%C Percent Output
	0	0	1	1	CO Factor or Equivalent
	0	0	1	1	H Factor or Equivalent

Controller	Source Location	Write Register	Read Scale	Write Scale	Description
Eurotherm 2500	1	1	1	1	%C Actual
(Modbus Mode)	5	5	1	1	%C Setpoint
	72	11073	1	1	Probe Temperature
<i>Assumes Loop 1 =</i>	61	11062	1	1	Probe Millivolts
<i>Atmosphere</i>	4	4	1	1	%C Percent Output

	68	11069	1	1	CO Factor or Equivalent
	68	11069	1	1	H Factor or Equivalent

Controller	Source Location	Write Register	Read Scale	Write Scale	Description
Carbpro 3.5	6	28	1	1	%C Actual
(MMI Mode)	1	1	1	1	%C Setpoint
	5	25	8	8	Probe Temperature
	4	24	8	8	Probe Millivolts
	11	117	1	1	%C Percent Output
	13	7	1	1	CO Factor or Equivalent
	14	8	1	1	H Factor or Equivalent

Controller	Source Location	Write Register	Read Scale	Write Scale	Description
Carbpro 3.0	6	28	4	4	%C Actual
(MMI Mode)	1	1	1	1	%C Setpoint
	5	25	8	8	Probe Temperature
	4	24	2	2	Probe Millivolts
	11	117	1	1	%C Percent Output
	13	7	1	1	CO Factor or Equivalent
	14	8	1	1	H Factor or Equivalent

Controller	Source Location	Write Register	Read Scale	Write Scale	Description
Carbpc	20	20	1	1	%C Actual
(MMI Mode)	6	6	1	1	%C Setpoint
	17	17	8	8	Probe Temperature
	18	18	8	8	Probe Millivolts
	64	64	41	41	%C Percent Output
	3	3	1	1	CO Factor or Equivalent
	4	4	1	1	H Factor or Equivalent

Controller	Source Location	Write Register	Read Scale	Write Scale	Description
Series 9200 Loop 1	3	126	1	1	%C Actual
	5	128	1	1	%C Setpoint
	22	145	1	1	Probe Temperature
	21	144	10	10	Probe Millivolts
	7	130	10	10	%C Percent Output
	19	142	1	1	CO Factor or Equivalent
	20	143	1	1	H Factor or Equivalent

Temperature Instruments

Controller	Source Location	Write Register	Read Scale	Write Scale	Description
Series 20	11	123	1	1	Temperature Controller Actual
(Modbus Mode)	30	138	1	1	Temperature Controller Setpoint
	18	130	10	10	Temperature Controller Percent Output

Controller	Source Location	Write Register	Read Scale	Write Scale	Description
Yokogawa 750	2	2	1	1	Temperature Controller Actual
(Modbus Mode)	3	100	1	1	Temperature Controller Setpoint
	4	4	10	10	Temperature Controller Percent Output

Controller	Source Location	Write Register	Read Scale	Write Scale	Description
UDC 3300's	1	0	10	10	Temperature Controller Actual
(Modbus Mode)	3	2	10	10	Temperature Controller Setpoint
	4	3	10	10	Temperature Controller Percent Output

Controller	Source Location	Write Register	Read Scale	Write Scale	Description
Dualpro Loop 1	18	17	8	8	Temperature Controller Actual
(Modbus Mode)	7	6	1	1	Temperature Controller Setpoint
	41	40	41	41	Temperature Controller Percent Output

Controller	Source Location	Write Register	Read Scale	Write Scale	Description
Dualpro Loop 2	18	17	8	8	Temperature Controller Actual
(Modbus Mode)	8	7	1	1	Temperature Controller Setpoint
	42	41	41	41	Temperature Controller Percent Output

Controller	Source Location	Write Register	Read Scale	Write Scale	Description
Dualpro Loop 1	17	17	8	8	Temperature Controller Actual
(MMI Mode)	6	6	1	1	Temperature Controller Setpoint
	40	40	41	41	Temperature Controller Percent Output

Controller	Source Location	Write Register	Read Scale	Write Scale	Description
Dualpro Loop 2	17	17	8	8	Temperature Controller Actual
(MMI Mode)	7	7	1	1	Temperature Controller Setpoint
	41	41	41	41	Temperature Controller Percent Output

Controller	Source Location	Write Register	Read Scale	Write Scale	Description
Eurotherm 2404	1	1	1	1	Temperature Controller Actual
(Modbus Mode)	2	2	1	1	Temperature Controller Setpoint
	3	3	10	10	Temperature Controller Percent Output

Controller	Source Location	Write Register	Read Scale	Write Scale	Description
Eurotherm 2500	26	1025	1	1	Temperature Controller Actual
(Modbus Mode)	27	1026	1	1	Temperature Controller Setpoint
<i>Assumes Loop 2 is Temperature</i>	29	1028	10	10	Temperature Controller Percent Output

Controller	Source Location	Write Register	Read Scale	Write Scale	Description
Unipro 3.5	3	25	8	8	Temperature Controller Actual
(MMI Mode)	1	1	1	1	Temperature Controller Setpoint
	5	118	1	1	Temperature Controller Percent Output

Controller	Source Location	Write Register	Read Scale	Write Scale	Description
Unipro 3.0	3	25	8	8	Temperature Controller Actual
(MMI Mode)	1	1	1	1	Temperature Controller Setpoint
	5	118	1	1	Temperature Controller Percent Output

Controller	Source Location	Write Register	Read Scale	Write Scale	Description
Carbpro 3.5 Slave	9	46	1	1	Temperature Controller Actual
(MMI Mode)	3	18	1	1	Temperature Controller Setpoint
	12	53	41	41	Temperature Controller Percent Output

Controller	Source Location	Write Register	Read Scale	Write Scale	Description
Carbpro 3.0 Slave	9	46	1	1	Temperature Controller Actual
(MMI Mode)	3	18	1	1	Temperature Controller Setpoint
	12	53	41	41	Temperature Controller Percent Output

Controller	Source Location	Write Register	Read Scale	Write Scale	Description
10Pro Slave or E Slave	2	2	1	1	Temperature Controller Actual
(MMI Mode)	3	3	1	1	Temperature Controller Setpoint
	4	4	1	1	Temperature Controller Percent Output

Controller	Source Location	Write Register	Read Scale	Write Scale	Description
Dualpro Input C	19	19	8	8	PV
	5	5	1	1	Setpoint Loop 1
	40	40	41	41	Percent Output Loop 1

Controller	Source Location	Write Register	Read Scale	Write Scale	Description
Series 9200 Loop 1	3	126	1	1	Temperature Controller Actual
	5	128	1	1	Temperature Controller Setpoint
	7	130	10	10	Temperature Controller Percent Output

Controller	Source Location	Write Register	Read Scale	Write Scale	Description
Series 9200 Loop 2	8	131	1	1	Temperature Controller Actual
	10	133	1	1	Temperature Controller Setpoint
	12	135	10	10	Temperature Controller Percent Output

Controller	Source Location	Write Register	Read Scale	Write Scale	Description
Series 9200 Loop 3	13	136	1	1	Temperature Controller Actual
	15	138	1	1	Temperature Controller Setpoint
	17	140	10	10	Temperature Controller Percent Output

Controller	Source Location	Write Register	Read Scale	Write Scale	Description
Series 9100 Loop 2	1	104	1	1	Temperature Controller Actual
	36	139	1	1	Temperature Controller Setpoint
	28	131	10	10	Temperature Controller Percent Output

Controller	Source Location	Write Register	Read Scale	Write Scale	Description
Eurotherm Loop 1 (Modbus Mode)	1	1	1	1	Temperature Controller Actual
	2	2	1	1	Temperature Controller Setpoint
	3	3	10	10	Temperature Controller Percent Output

Controller	Source Location	Write Register	Read Scale	Write Scale	Description
Eurotherm Loop 2 (Modbus Mode)	26	1025	1	1	Temperature Controller Actual
	27	1026	1	1	Temperature Controller Setpoint
	29	1028	10	10	Temperature Controller Percent Output

Controller	Source Location	Write Register	Read Scale	Write Scale	Description
Eurotherm Loop 3 (Modbus Mode)	51	1049	1	1	Temperature Controller Actual
	52	1050	1	1	Temperature Controller Setpoint
	53	1052	10	10	Temperature Controller Percent Output

Controller	Source Location	Write Register	Read Scale	Write Scale	Description
9500 Valve Controller Valve 1	30	130	1	1	Flow Actual
	56	156	1	1	Flow Setpoint
	54	154	1	1	Flow Percent of Full Scale

Controller	Source Location	Write Register	Read Scale	Write Scale	Description
9500 Valve Controller Valve 2	31	131	1	1	Flow Actual
	66	166	1	1	Flow Setpoint
	64	164	1	1	Flow Percent of Full Scale

Controller	Source Location	Write Register	Read Scale	Write Scale	Description
9500 Valve Controller Valve 3	32	132	1	1	Flow Actual
	76	176	1	1	Flow Setpoint
	74	174	1	1	Flow Percent of Full Scale

Controller	Source Location	Write Register	Read Scale	Write Scale	Description
9500 Valve Controller Valve 4	33	133	1	1	Flow Actual
	86	186	1	1	Flow Setpoint
	84	184	1	1	Flow Percent of Full Scale

Controller	Source Location	Write Register	Read Scale	Write Scale	Description
SSi 7SL Limit Controller	4	123	1	1	Limit Controller Actual
	8	177	1	1	Limit Controller Alarm Threshold (SP)
	11	310	1	1	Limit Controller Main Setpoint

Controller	Source Location	Write Register	Read Scale	Write Scale	Description
Flow Meter	1	16	1	1	Flow
	3	18	1	1	Setpoint
	0	0	1	1	<i>No Value Available</i>

Controller	Source Location	Write Register	Read Scale	Write Scale	Description
UMC 800 Loop 1	0	64	1	1	PV Actual
<i>All Values are</i>	4	68	1	1	Working Setpoint
<i>Floating Point</i>	6	70	1	1	Percent Output

Controller	Source Location	Write Register	Read Scale	Write Scale	Description
SSi Quad DAC Ch. 0	10	10	1	1	DAC Out
	10	10	1	1	DAC Out
	16	16	1	1	<i>No Value Available</i>

Controller	Source Location	Write Register	Read Scale	Write Scale	Description
SSi Quad DAC Ch. 1	11	11	1	1	DAC Out
	11	11	1	1	DAC Out
	16	16	1	1	<i>No Value Available</i>

Controller	Source Location	Write Register	Read Scale	Write Scale	Description
SSi Quad DAC Ch. 2	12	12	1	1	DAC Out
	12	12	1	1	DAC Out
	16	16	1	1	<i>No Value Available</i>

Controller	Source Location	Write Register	Read Scale	Write Scale	Description
SSi Quad DAC Ch. 3	13	13	1	1	DAC Out
	13	13	1	1	DAC Out
	16	16	1	1	<i>No Value Available</i>

Controller	Source Location	Write Register	Read Scale	Write Scale	Description
Yokogawa UT350/320	2	2	1	1	Temperature Controller Actual
(Modbus Mode)	3	300	1	1	Temperature Controller Setpoint
	4	4	10	10	Temperature Controller Percent Output

Controller	Source Location	Write Register	Read Scale	Write Scale	Description
Yokogawa UP750/550 Loop 2	18	18	1	1	Temperature Controller Actual
(Modbus Mode)	19	101	1	1	Temperature Controller Setpoint
	20	20	10	10	Temperature Controller Percent Output

Controller	Source Location	Write Register	Read Scale	Write Scale	Description
Yokogawa UP350	2	2	1	1	Temperature Controller Actual
(Modbus Mode)	3	138	1	1	Temperature Controller Setpoint
	4	4	10	10	Temperature Controller Percent Output

Controller	Source Location	Write Register	Read Scale	Write Scale	Description
Honeywell DCP551	4	259	10	10	Temperature Controller Actual
	5	702	10	10	Temperature Controller Setpoint
	0	0	10	10	Temperature Controller Percent Output

Events Instruments

Controller	Source Location	Write Register	Read Scale	Write Scale	Description
AC20	50	310	1	1	Events Actual
(Modbus Mode)	50	310	1	1	Events Setpoint
	49	300	1	1	Events Input

Controller	Source Location	Write Register	Read Scale	Write Scale	Description
Yokogawa 750	49	310	1	1	Events Actual
(Modbus Mode)	49	310	1	1	Events Setpoint
	49	310	1	1	Events Input

Controller	Source Location	Write Register	Read Scale	Write Scale	Description
ModMux	97	97	1	1	Events Actual
(Modbus Mode)	97	97	1	1	Events Setpoint
	98	98	1	1	Events Input

Controller	Source Location	Write Register	Read Scale	Write Scale	Description
Dualpro Events	59	178	1	1	Events Actual
(Modbus Mode)	49	168	1	1	Events Setpoint
	59	178	1	1	Events Input

Controller	Source Location	Write Register	Read Scale	Write Scale	Description
Dualpro Events	82	178	1	1	Events Actual
(MMI Mode)	72	168	1	1	Events Setpoint
	82	178	1	1	Events Input

Controller	Source Location	Write Register	Read Scale	Write Scale	Description
Carbpro 3.5 Events	8	43	1	1	Events Actual
(MMI Mode)	2	17	1	1	Events Setpoint
	8	43	1	1	Events Input

Controller	Source Location	Write Register	Read Scale	Write Scale	Description
Carbpro 3.0 Events	8	43	1	1	Events Actual
(MMI Mode)	2	17	1	1	Events Setpoint
	8	43	1	1	Events Input

Controller	Source Location	Write Register	Read Scale	Write Scale	Description
Eurotherm 2500	19	19	8	8	PV
(Modbus Mode)	5	5	1	1	Setpoint Loop 1
	40	40	1	1	Percent Output Loop 1

Controller	Source Location	Write Register	Read Scale	Write Scale	Description
SSi_8_8	5	100	1	1	Events Actual
	3	98	1	1	Events Setpoint
	6	101	1	1	Events Input

Controller	Source Location	Write Register	Read Scale	Write Scale	Description
Series 9200	5	176	1	1	Events Actual
	2	109	1	1	Events Setpoint
	4	175	1	1	Events Input

Controller	Source Location	Write Register	Read Scale	Write Scale	Description
Micrologix Modbus	10	110	1	1	Events Actual
RS-232	0	100	1	1	Events Setpoint
	15	115	1	1	Events Input

Controller	Source Location	Write Register	Read Scale	Write Scale	Description
MCMModule Modbus	10	110	1	1	Events Actual
RS-232	0	100	1	1	Events Setpoint
	15	115	1	1	Events Input

Controller	Source Location	Write Register	Read Scale	Write Scale	Description
PLC5DF1	10	110	1	1	Events Actual
RS-232	0	100	1	1	Events Setpoint
	15	115	1	1	Events Input

Controller	Source Location	Write Register	Read Scale	Write Scale	Description
SLKDF1	10	110	1	1	Events Actual
RS-232	0	100	1	1	Events Setpoint
	15	115	1	1	Events Input

Appendix B – Series 9010 Wiring Diagram

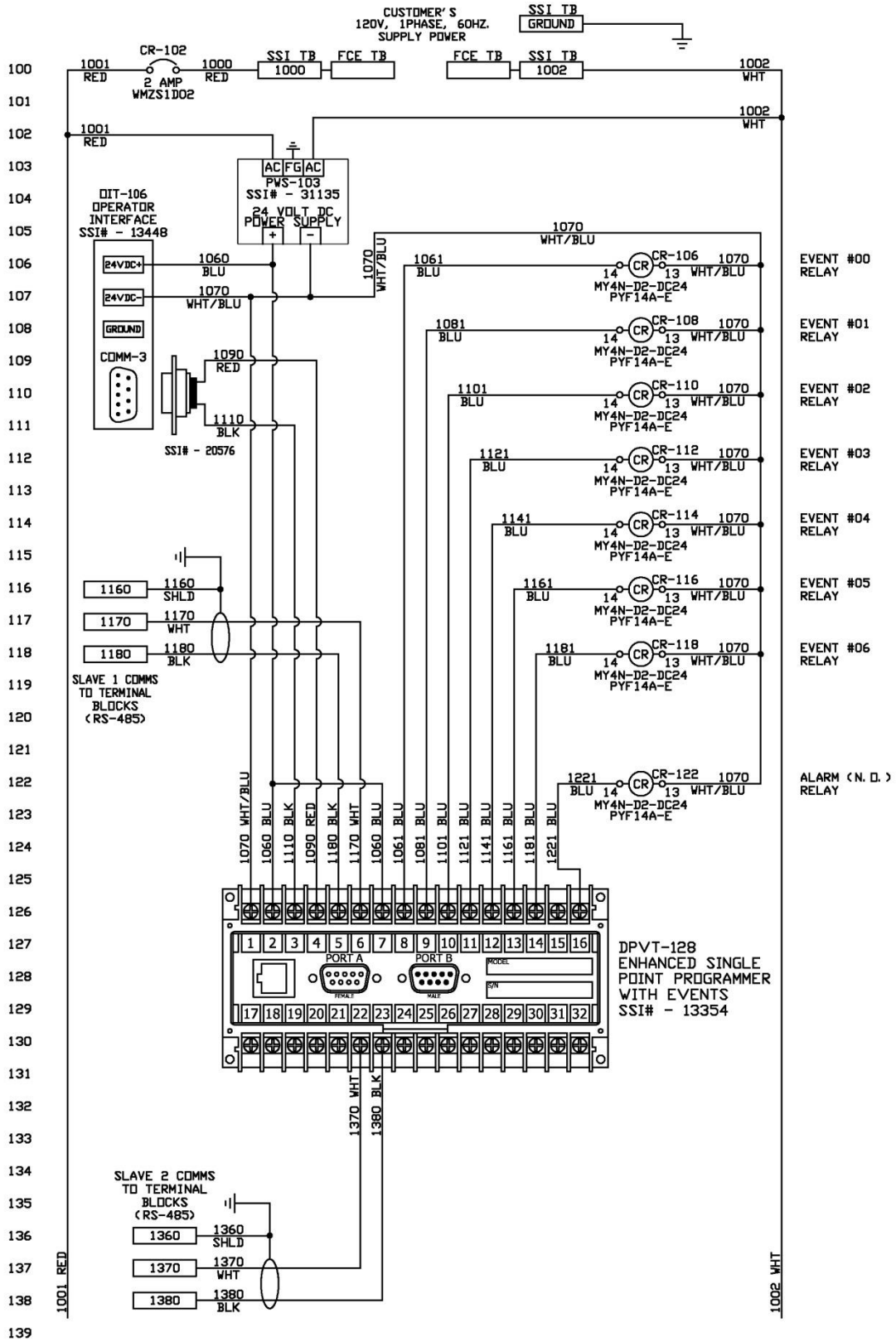

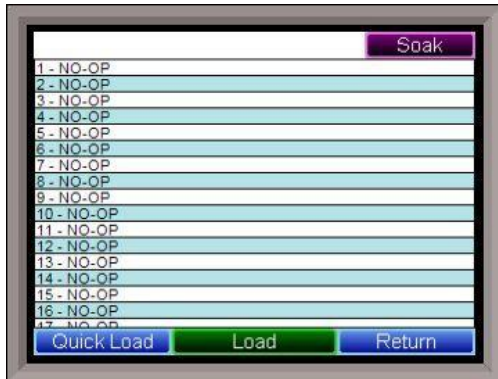

When MiniBatch is in operation, the *Recipe* screen off of the main status display will now have a new button labeled **Quick Load**. Quick Load will load up one of the MiniBatch recipes set up without actually creating a corresponding load record. This would be used if the user wanted to run a recipe without creating a new load for the recipe.

Clicking on the **Load** button will launch the MiniBatch application. *Note – MiniBatch can only run one recipe at a time.* The buttons at the top of the screen will display the new load screen or the currently running load screen (**Load**), or the load history (**History**). The **Return** button will close down MiniBatch and return to the *Recipe* screen. To begin, the user will have to select a user that has been set up, enter the password, then give the load a meaningful name. Once this has been done, parts can be added to the load by clicking on the **Add Parts** button.

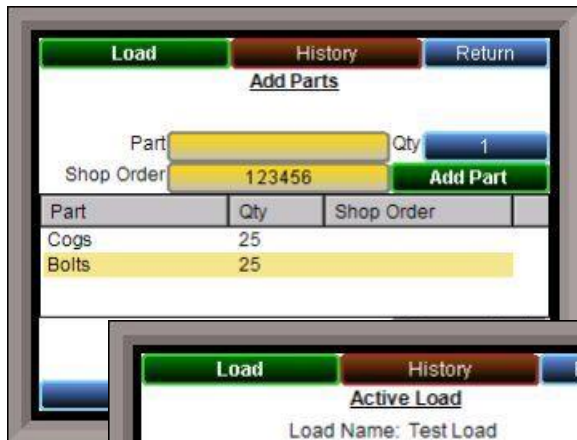

Click on the button next to the “Part” label to select parts that have been set up. Once a part has been selected, the quantity of the part can be changed by clicking on the button next to the “Qty” label. The shop order can be added for the part by clicking on the button next to the “Shop Order” label. Once the appropriate part, quantity, and shop order have been selected, click on the **Add Part** button to add the part

the
to
the
verify
recipe
button
to the



to the list. *Only parts in the list will be considered part of the load.* Add as many parts as desired. *Note – A shop order must be entered for each part.* To remove a part from the list, and therefore, the load, select part in the list and click on the **Remove Part** button. Once all of the parts have been selected, click on the **Choose Recipe** button select the recipe to run. The user can select recipe to run and even preview the recipe to that it is the correct recipe desired. If the is correct, then click on the **Start Load** to start the recipe and add the load record database. The active load screen will be

shown, with a summary of the load composition, as well as when the load was started. The load will not be marked complete when the recipe ends, so the load will need to be manually marked as complete. Clicking on the **Mark Complete** button will mark the load a finished.

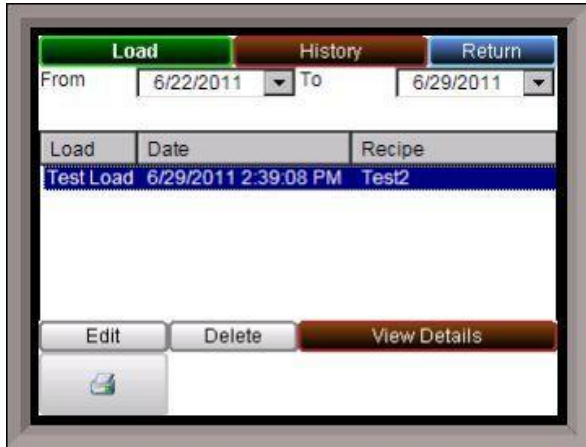

Any completed loads can be viewed on the Load History screen, which is accessed by clicking on the **History** button at the top of the screen. The loads for the given time frame will be listed in the list. The time frame can be changed by clicking on the down arrow next to the "From" or "To" dates. *Note - There is no refresh, so the user will have to click on the **Load** button, then click on the **History** button for the history to list all of the loads for the new time frame.* Select a load to be able to alter it. Clicking on the **Delete** button will allow the user to delete a specific load record. A record must be selected before it can be deleted. This will be helpful if the database is getting too full, or too many records are displayed on the screen and the loading time is

pretty long

The features of the **Edit** button have not yet been implemented.

To print, the touch screen must be connected to a MiniBatch server PC, and the printers can be selected from that PC.

Clicking on the **View Details** button will display the parts in the load, along with the operator who started the load and the time that the load ran. Any additional user fields will also be displayed. From this screen, clicking on the **Chart** Button will display the chart screen for the specific load and only for the load's run time (Start Time - End Time).



Appendix D – Data and Flash Card Management

This appendix will show the user how to pull logged data from the operator interface using TS Manager.

From the TS Manager home screen, select Tools → Communications → Advanced Download & Maintenance

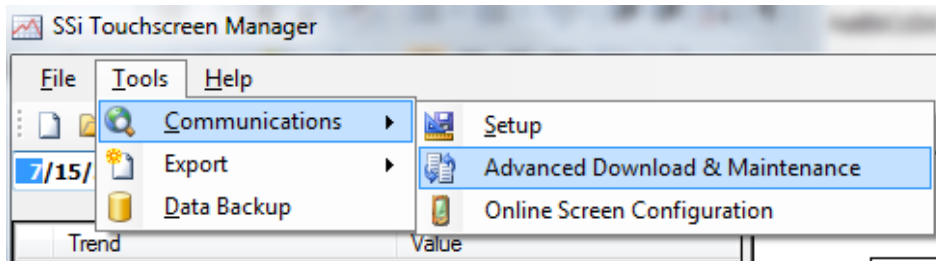

The Transfer Data tab is used to download data from the selected touch screen. The specified recorder is identified on the drop down list from the main TS Manager Screen.

There are 2 ways to synchronize data. This can be done using the Screen as the source of the data (network connection) or Disk source (flash card from the screen). *Note: Users can also download data from the main TS Manager screen using the "Download Data" button on the top right corner.*

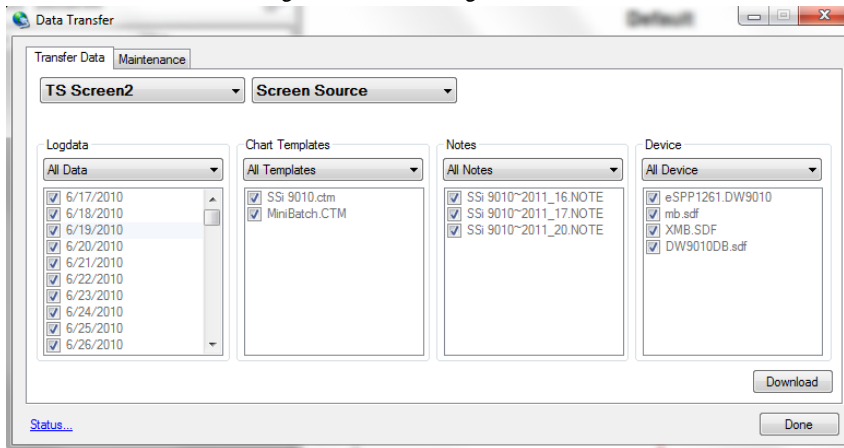

Synchronization will pull all Log Data, Chart Templates, Notes, and Devices that were entered on the screen onto the computer that is running TS Manager. The data will be stored in the TSManger directory under the screen name.

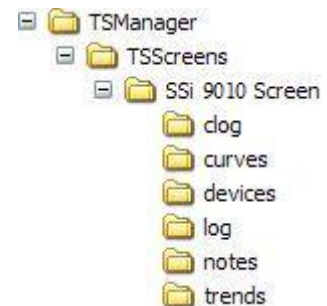

Log Data – Users can use the drop down list to select: All Data, Selected Data, or Skip. The check boxes are used to select which data gets included for the download when the Selected Data is selected, or which data gets skipped when the Skip option is selected.

Chart Templates – User can use the drop down list to select: All Templates, Selected Templates, or Skip. The check boxes are used to select which templates get included for the download when the Selected Templates is selected, or which templates get skipped when the Skip option is selected.

Notes – User can use the drop down list to select: All Notes, Selected Notes, or Skip. The check boxes are used to select which notes get included for the download when the Selected Notes is selected, or which notes get skipped when the Skip option is selected.

Devices – Users can use the drop down list to select: All Device, Selected Device, or Skip. The check boxes are used to select which devices get included for the download when the Selected Device is selected, or which devices get skipped when the Skip option is selected.

The **Download** button  is used to start the synchronization process.

Note: A file that is downloaded will overwrite any existing file.

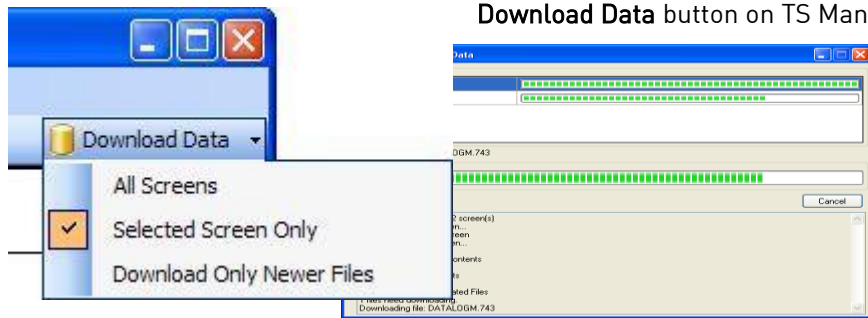

Download Data button on TS Manager main screen.

Clicking on the down arrow will give the user the ability to: download data from all of the touch screen definitions, download data from the selected screen, only download newer files. Clicking on the button will begin the download progress. multiple screens, then each

If there are screen will be displayed along with the progress of each download. Clicking on the "Show Details" link will expand the screen and show any download details. The link will then say "Hide Details", which will shrink the screen and not provide any details. If there are any errors with downloading, then there will be an "X" next to the screen with the issue. The error will be listed in the details section. If the download is successful, then the download screen will close when the download is finished.

Flash Card Synchronization

When synchronizing from a flash card, the flash card needs to be retrieved from the touch screen. **The screen should be turned off before pulling the flashcard.**

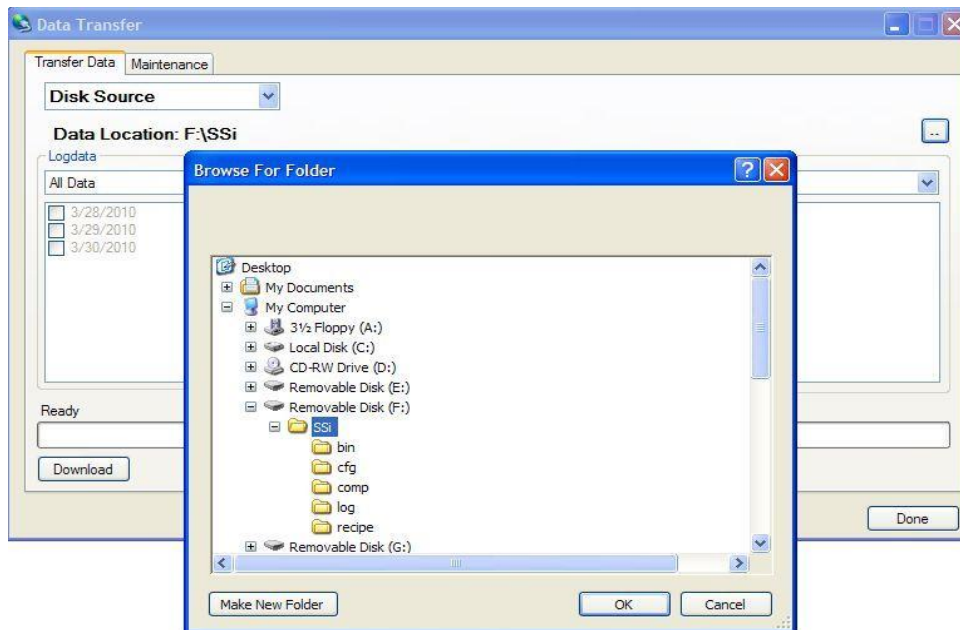

The storage location of the flash card should be selected using the period

button  on the Data Transfer screen's Transfer Data tab. *Note: The main location for the flash drive should be selected.*

The Maintenance tab is used to delete logged data or notes either from the video screen directly or on the flash card. Logged data and notes can be removed to create additional free space on the storage card.

All data that is synchronized with TS Manager maintains a backup of the data in the

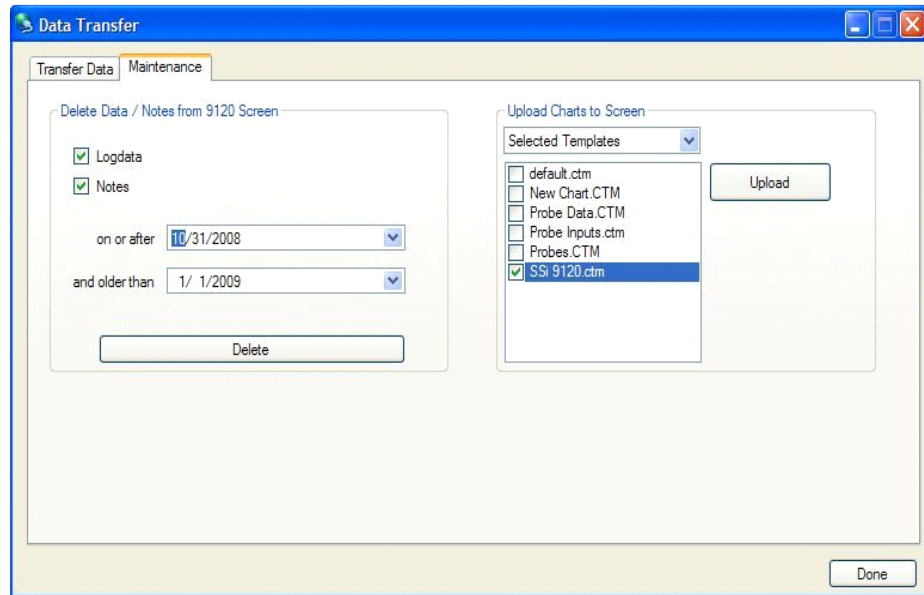

..TSManger\TSScreens\“Screen Name”\Log, Clog and notes directories.

To delete the log data, select the “Logdata” option, and to delete the notes, select the “Notes” option. One or both options may be selected at the same time. The data will be deleted by a date range, which means the user will have to select a beginning date for the date range and an ending date for the date range. The “on or after” drop-down list is the beginning date for the date range, and the “and older than” drop-down list is the ending date for the date range. Clicking on the **Delete** button will delete the selected files from the screen. The user will have to confirm the delete. The user will also be able to upload chart files to the instrument. In the “Upload Charts to Screen” section, the drop-down list has the options for “All Templates” or “Selected Templates”. Click on the **Upload** button to upload the desired chart files. This feature is useful if the user modifies the chart files on the local computer and wishes to update the chart files on the touch screen without having to enter the modifications again. The **Done** button will close out the screen.

Here is an example of a finished recipe.

The screenshot shows a recipe editing interface with a title bar containing 'Load' and 'Save' buttons. Below the title bar, the text 'Editing recipe 1' is displayed. The main area contains a table with 12 rows of recipe steps. At the bottom, there are four buttons: 'Edit', 'Insert', 'Delete', and 'Return'.

Load		Save	
Editing recipe 1			
1 - SETPT	1700 °F		wait
2 - SETPT	1700 °F	1.00 %C	wait
3 - SOAK			0:01
4 - EVT_OUT			3-ON
5 - SETPT	1600 °F		wait
6 - DELAY			5 sec
7 - EVT_OUT			3-OFF
8 - SETPT	1600 °F	0.80 %C	wait
9 - SOAK			0:01
10 - EVT_OUT			COOL-ON
11 - ALARM			End Cycle
12 - EVT_OUT			COOL-OFF

Buttons: Edit, Insert, Delete, Return

Warranty

Limited Warranty for Super Systems Products:

The Limited Warranty applies to new Super Systems Inc. (SSI) products purchased direct from SSI or from an authorized SSI dealer by the original purchaser for normal use. SSI warrants that a covered product is free from defects in materials and workmanship, with the exceptions stated below.

The limited warranty does not cover damage resulting from commercial use, misuse, accident, modification or alteration to hardware or software, tampering, unsuitable physical or operating environment beyond product specifications, improper maintenance, or failure caused by a product for which SSI is not responsible. There is no warranty of uninterrupted or error-free operation. There is no warranty for loss of data—you must regularly back up the data stored on your product to a separate storage product. There is no warranty for product with removed or altered identification labels. SSI DOES NOT PROVIDE ANY OTHER WARRANTIES OF ANY KIND, INCLUDING, BUT NOT LIMITED TO, THE IMPLIED WARRANTIES OR CONDITIONS OF MERCHANTABILITY AND FITNESS FOR A PARTICULAR PURPOSE. SOME JURISDICTIONS DO NOT ALLOW THE LIMITATION OF IMPLIED WARRANTIES, SO THIS LIMITATION MAY NOT APPLY TO YOU. SSI is not responsible for returning to you product which is not covered by this limited warranty.

If you are having trouble with a product, before seeking limited warranty service, first follow the troubleshooting procedures that SSI or your authorized SSI dealer provides.

SSI will replace the PRODUCT with a functionally equivalent replacement product, transportation prepaid after PRODUCT has been returned to SSI for testing and evaluation. SSI may replace your product with a product that was previously used, repaired and tested to meet SSI specifications. You receive title to the replaced product at delivery to carrier at SSI shipping point. You are responsible for importation of the replaced product, if applicable. SSI will not return the original product to you; therefore, you are responsible for moving data to another media before returning to SSI, if applicable. Data Recovery is not covered under this warranty and is not part of the warranty returns process. SSI warrants that the replaced products are covered for the remainder of the original product warranty or 90 days, whichever is greater.

Revision History

Rev.	Description	Date	MCO #
A	Added User Alarm 0 function	10/24/11	N/A
B	Added reference to TS Manager manual for changing IP address, mask, and gateway of touchscreen.	5/26/2017	2215
C	Added Backup/Restore options	2/2/2018	2227
D	Added operating range	7/28/2018	2235
E	Added TS Mounting Instructions	12/3/2018	2245
F	Changed number of steps reference in recipe section to 12.	9/25/2019	2270
G	Added Load TC Map and Chart Settings	6/8/2022	2324
H	Clarified Wait/Wait Up/Wait Down	9/9/2022	2327